

A Mediant Hexany (listed at top left)  
flanked by a pair of like hexanies (listed on the right)  
Sharing the 4 pairs of triads of three like factors (listed on the left)  
that occur a set distance apart (white circle/black circle)  
resulting in a 12 tone structure

<u>1 3 5 7</u>	<u>9</u>	<u>11</u>	<u>1 3 9 11</u>	<u>5</u>	<u>7</u>	<u>3 5 7 9</u>	<u>1</u>	<u>11</u>
1 3 5	1 3 5 9	1 3 5 11	1 3 9	1 3 5 9	1 3 7 9	3 5 7	1 3 5 7	3 5 7 11
1 3 7	1 3 7 9	1 3 7 11	1 3 11	1 3 5 11	1 3 7 11	3 5 9	1 3 5 9	3 5 9 11
1 5 7	1 5 7 9	1 5 7 11	1 9 11	1 5 9 11	1 7 9 11	3 7 9	1 3 7 9	3 7 9 11
3 5 7	3 5 7 9	3 5 7 11	3 9 11	3 5 9 11	3 7 9 11	5 7 9	1 5 7 9	5 7 9 11

<u>1 3 5 9</u>	<u>7</u>	<u>11</u>	<u>1 5 7 9</u>	<u>3</u>	<u>11</u>	<u>3 5 7 11</u>	<u>1</u>	<u>9</u>
1 3 5	1 3 5 7	1 3 5 11	1 5 7	1 3 5 7	1 5 7 11	3 5 7	1 3 5 7	3 5 7 9
1 3 9	1 3 7 9	1 3 9 11	1 5 9	1 3 5 9	1 5 9 11	3 5 11	1 3 5 11	3 5 9 11
1 5 9	1 5 7 9	1 5 9 11	1 7 9	1 3 7 9	1 7 9 11	3 7 11	1 3 7 11	3 7 9 11
3 5 9	3 5 7 9	3 5 9 11	5 7 9	3 5 7 9	5 7 9 11	5 7 11	1 5 7 11	5 7 9 11

<u>1 3 5 11</u>	<u>7</u>	<u>9</u>	<u>1 5 7 11</u>	<u>3</u>	<u>9</u>	<u>3 5 9 11</u>	<u>1</u>	<u>7</u>
1 3 5	1 3 5 7	1 3 5 9	1 5 7	1 3 5 7	1 5 7 9	3 5 9	1 3 5 9	3 5 7 9
1 3 11	1 3 7 11	1 3 9 11	1 5 11	1 3 5 11	1 5 9 11	3 5 11	1 3 5 11	3 5 7 11
1 5 11	1 5 7 11	1 5 9 11	1 7 11	1 3 7 11	1 7 9 11	3 9 11	1 3 9 11	3 7 9 11
3 5 11	3 5 7 11	3 5 9 11	5 7 11	3 5 7 11	5 7 9 11	5 9 11	1 5 9 11	5 7 9 11

<u>1 3 7 9</u>	<u>5</u>	<u>11</u>	<u>1 5 9 11</u>	<u>3</u>	<u>7</u>	<u>3 7 9 11</u>	<u>1</u>	<u>5</u>
1 3 7	1 3 5 7	1 3 7 11	1 5 9	1 3 5 9	1 5 7 9	3 7 9	1 3 7 9	3 5 7 9
1 3 9	1 3 5 9	1 3 9 11	1 5 11	1 3 5 11	1 5 7 11	3 7 11	1 3 7 11	3 5 7 11
1 7 9	1 5 7 9	1 7 9 11	1 9 11	1 3 9 11	1 7 9 11	3 9 11	1 3 9 11	3 5 9 11
3 7 9	3 5 7 9	3 7 9 11	5 9 11	3 5 9 11	5 7 9 11	7 9 11	1 7 9 11	5 7 9 11

<u>1 3 7 11</u>	<u>5</u>	<u>9</u>	<u>1 7 9 11</u>	<u>3</u>	<u>5</u>	<u>5 7 9 11</u>	<u>1</u>	<u>3</u>
1 3 7	1 3 5 7	1 3 7 9	1 7 9	1 3 7 9	1 5 7 9	5 7 9	1 5 7 9	3 5 7 9
1 3 11	1 3 5 11	1 3 9 11	1 7 11	1 3 7 11	1 5 7 11	5 7 11	1 5 7 11	3 5 7 11
1 7 11	1 5 7 11	1 7 9 11	1 9 11	1 3 9 11	1 5 9 11	5 9 11	1 5 9 11	3 5 9 11
3 7 11	3 5 7 11	3 7 9 11	7 9 11	3 7 9 11	5 7 9 11	7 9 11	1 7 9 11	3 7 9 11

This cryptic table describes the 120 modulations or the 120 face-flankings

Median Hexony →	flanking Hexony			<u>1 3 9 11</u>	<u>5</u>	<u>7</u>	<u>3 5 7 9</u>	<u>1</u>	<u>11</u>
	<u>1 3 5 7</u>	<u>9</u>	<u>11</u>						
Common facets	1 3 5	1 3 5 9	1 3 5 11	1 3 9	1 3 5 9	1 3 7 9	3 5 7	1 3 5 7	3 5 7 11
	1 3 7	1 3 7 9	1 3 7 11	1 3 11	1 3 5 11	1 3 7 11	3 5 9	1 3 5 9	3 5 9 11
	1 5 7	1 5 7 9	1 5 7 11	1 9 11	1 5 9 11	1 7 9 11	3 7 9	1 3 7 9	3 7 9 11
	3 5 7	3 5 7 9	3 5 7 11	3 9 11	3 5 9 11	3 7 9 11	5 7 9	1 5 7 9	5 7 9 11

<u>1 3 5 9</u>	<u>7</u>	<u>11</u>	<u>1 5 7 9</u>	<u>3</u>	<u>11</u>	<u>3 5 7 11</u>	<u>1</u>	<u>9</u>
1 3 5	1 3 5 7	1 3 5 11	1 5 7	1 3 5 7	1 5 7 11	3 5 7	1 3 5 7	3 5 7 9
1 3 9	1 3 7 9	1 3 9 11	1 5 9	1 3 5 9	1 5 9 11	3 5 11	1 3 5 11	3 5 9 11
1 5 9	1 5 7 9	1 5 9 11	1 7 9	1 3 7 9	1 7 9 11	3 7 11	1 3 7 11	3 7 9 11
3 5 9	3 5 7 9	3 5 9 11	5 7 9	3 5 7 9	5 7 9 11	5 7 11	1 5 7 11	5 7 9 11

<u>1 3 5 11</u>	<u>7</u>	<u>9</u>	<u>1 5 7 11</u>	<u>3</u>	<u>9</u>	<u>3 5 9 11</u>	<u>1</u>	<u>7</u>
1 3 5	1 3 5 7	1 3 5 9	1 5 7	1 3 5 7	1 5 7 9	3 5 9	1 3 5 9	3 5 7 9
1 3 11	1 3 7 11	1 3 9 11	1 5 11	1 3 5 11	1 5 9 11	3 5 11	1 3 5 11	3 5 7 11
1 5 11	1 5 7 11	1 5 9 11	1 7 11	1 3 7 11	1 7 9 11	3 9 11	1 3 9 11	3 7 9 11
3 5 11	3 5 7 11	3 5 9 11	5 7 11	3 5 7 11	5 7 9 11	5 9 11	1 5 9 11	5 7 9 11

<u>1 3 7 9</u>	<u>5</u>	<u>11</u>	<u>1 5 9 11</u>	<u>3</u>	<u>7</u>	<u>3 7 9 11</u>	<u>1</u>	<u>5</u>
1 3 7	1 3 5 7	1 3 7 11	1 5 9	1 3 5 9	1 5 7 9	3 7 9	1 3 7 9	3 5 7 9
1 3 9	1 3 5 9	1 3 9 11	1 5 11	1 3 5 11	1 5 7 11	3 7 11	1 3 7 11	3 5 7 11
1 7 9	1 5 7 9	1 7 9 11	1 9 11	1 3 9 11	1 7 9 11	3 9 11	1 3 9 11	3 5 9 11
3 7 9	3 5 7 9	3 7 9 11	5 9 11	3 5 9 11	5 7 9 11	7 9 11	1 7 9 11	5 7 9 11

<u>1 3 7 11</u>	<u>5</u>	<u>9</u>	<u>1 7 9 11</u>	<u>3</u>	<u>5</u>	<u>5 7 9 11</u>	<u>1</u>	<u>3</u>
1 3 7	1 3 5 7	1 3 7 9	1 7 9	1 3 7 9	1 5 7 9	5 7 9	1 5 7 9	3 5 7 9
1 3 11	1 3 5 11	1 3 9 11	1 7 11	1 3 7 11	1 5 7 11	5 7 11	1 5 7 11	3 5 7 11
1 7 11	1 5 7 11	1 7 9 11	1 9 11	1 3 9 11	1 5 9 11	5 9 11	1 5 9 11	3 5 9 11
3 7 11	3 5 7 11	3 7 9 11	7 9 11	3 7 9 11	5 7 9 11	7 9 11	1 7 9 11	3 7 9 11

1 3 5 7

9

1 3 5

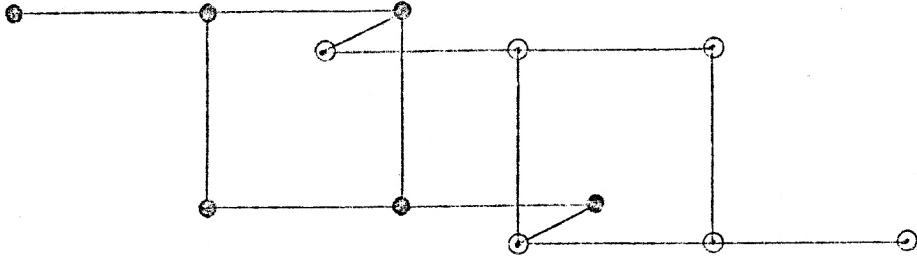

1 3 5 9

$$\frac{0}{\bullet} = \frac{9}{7}$$

1 3 7

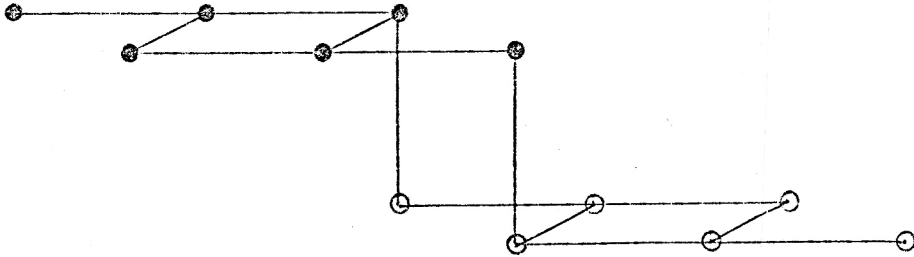

1 3 7 9

$$\frac{0}{\bullet} = \frac{9}{5}$$

1 5 7

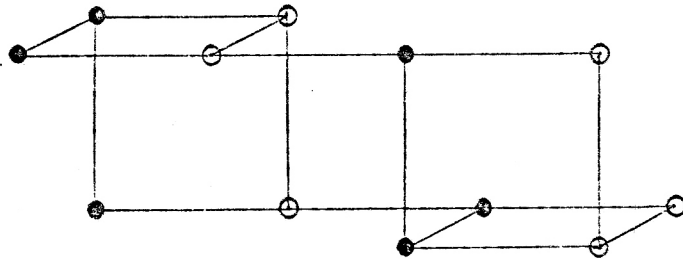

1 5 7 9

$$\frac{0}{\bullet} = \frac{9}{3}$$

3 5 7

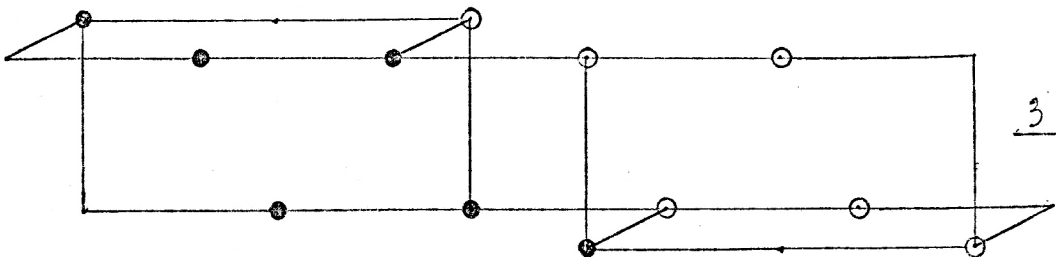

3 5 7 9

$$\frac{0}{\bullet} = \frac{9}{1}$$

1 3 5 7

1 3 5

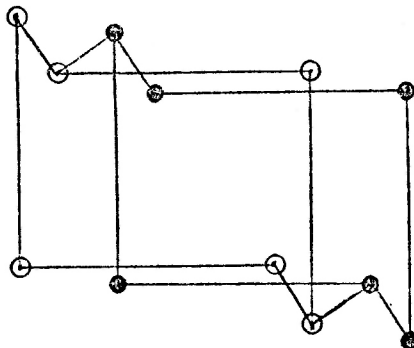

11

1 3 5 11

$$\frac{\circ}{\bullet} = \frac{11}{7}$$

1 3 7

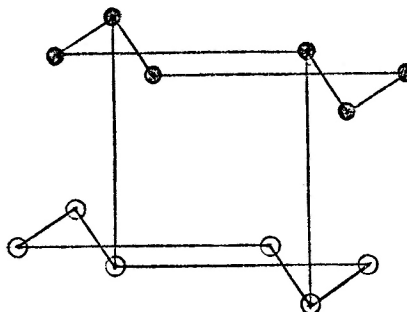

1 3 7 11

$$\frac{\circ}{\bullet} = \frac{11}{5}$$

1 5 7

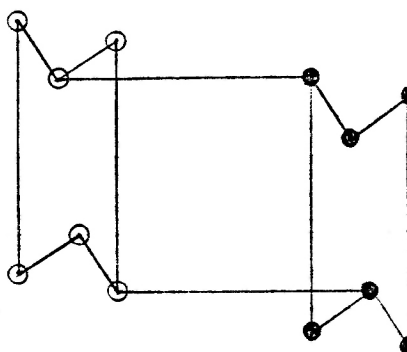

1 5 7 11

$$\frac{\circ}{\bullet} = \frac{11}{3}$$

3 5 7

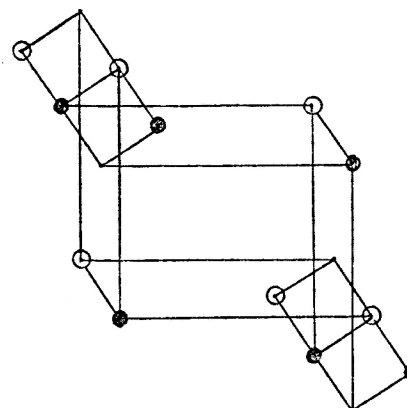

3 5 7 11

$$\frac{\circ}{\bullet} = \frac{11}{1}$$

1359

7

135

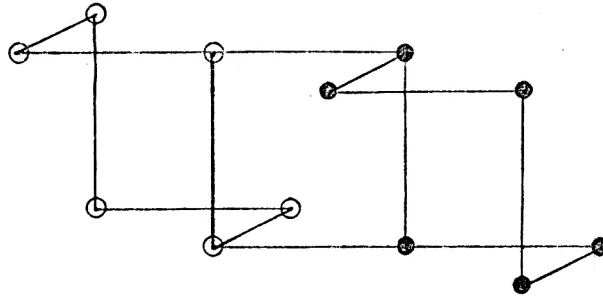

1357

$$\frac{0}{\bullet} = \frac{7}{9}$$

13 9

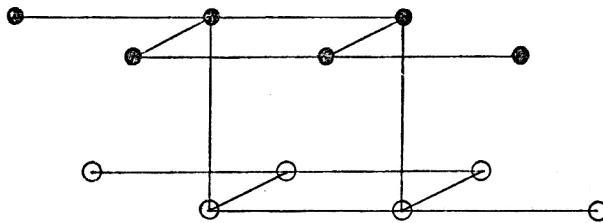

1379

$$\frac{0}{\bullet} = \frac{7}{5}$$

1 59

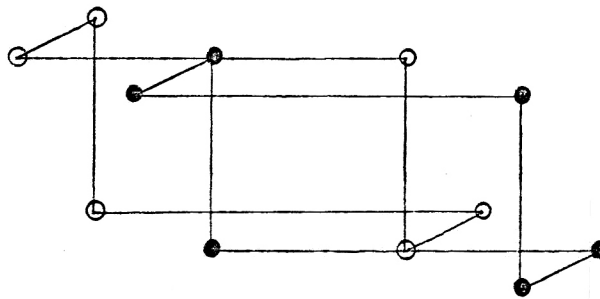

1579

$$\frac{0}{\bullet} = \frac{7}{3}$$

359

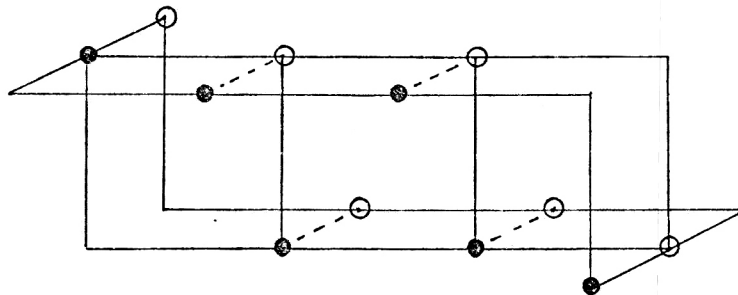

3579

$$\frac{0}{\bullet} = \frac{7}{1}$$

1359

11

135

135 11

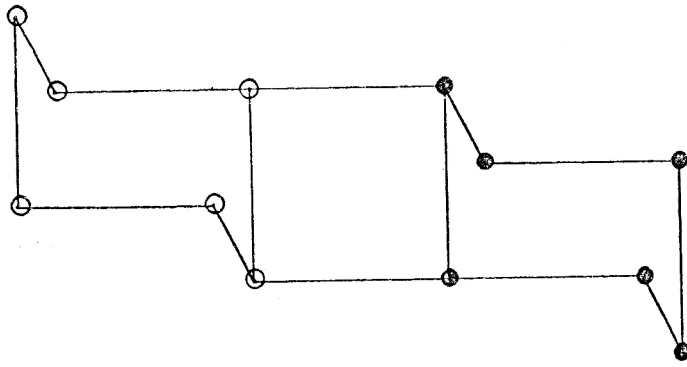

$$\frac{0}{6} = \frac{11}{9}$$

13 9

139 11

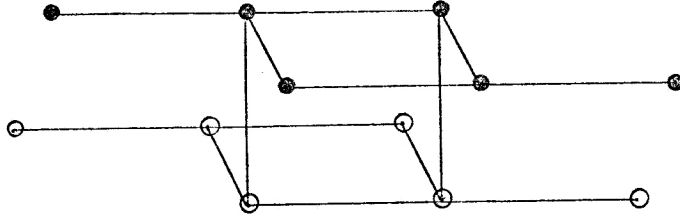

$$\frac{0}{4} = \frac{11}{5}$$

1 59

159 11

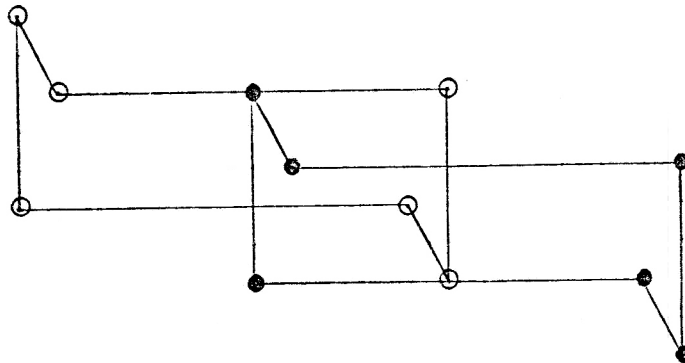

$$\frac{0}{2} = \frac{11}{3}$$

359

359 11

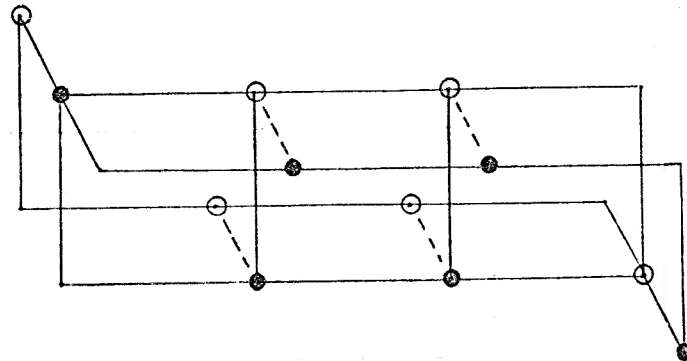

$$\frac{0}{6} = \frac{11}{1}$$

1 3 5 11

7

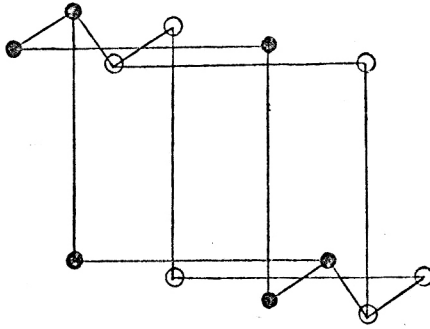

1 3 5 7

1 3 5

$$\frac{0}{\bullet} = \frac{7}{11}$$

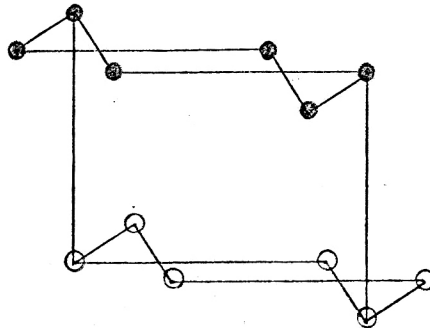

1 3 7 11

1 3 11

$$\frac{0}{\bullet} = \frac{7}{5}$$

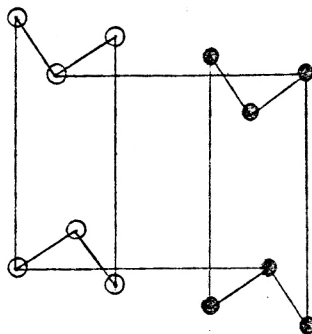

1 5 7 11

1 5 11

$$\frac{0}{\bullet} = \frac{7}{3}$$

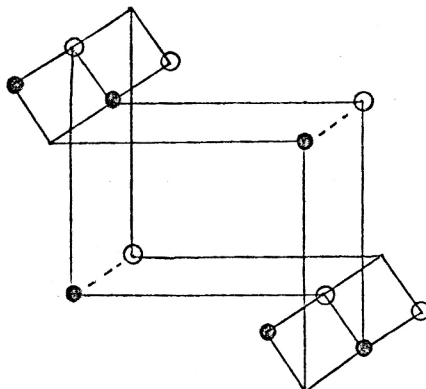

3 5 7 11

3 5 11

$$\frac{0}{\bullet} = \frac{7}{1}$$



1 3 5 11

9

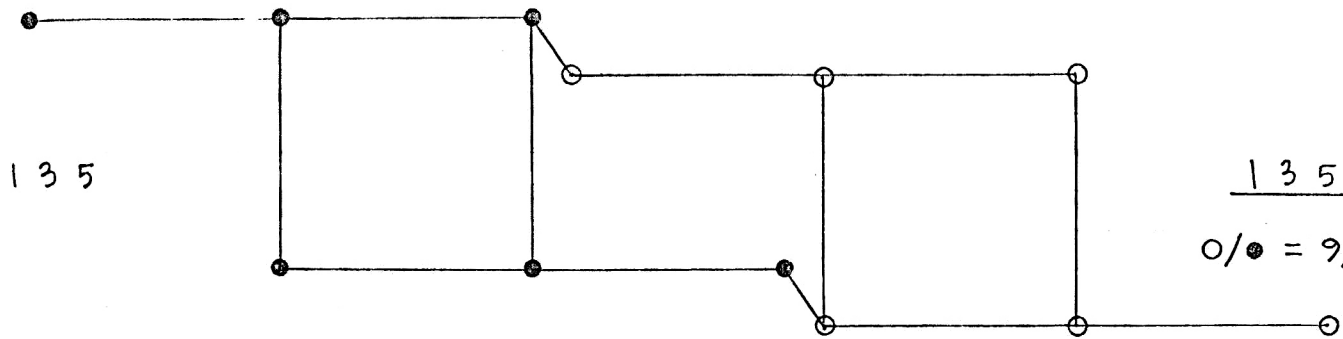

1 3 5

1 3 5 9  
 0/● = 9/11

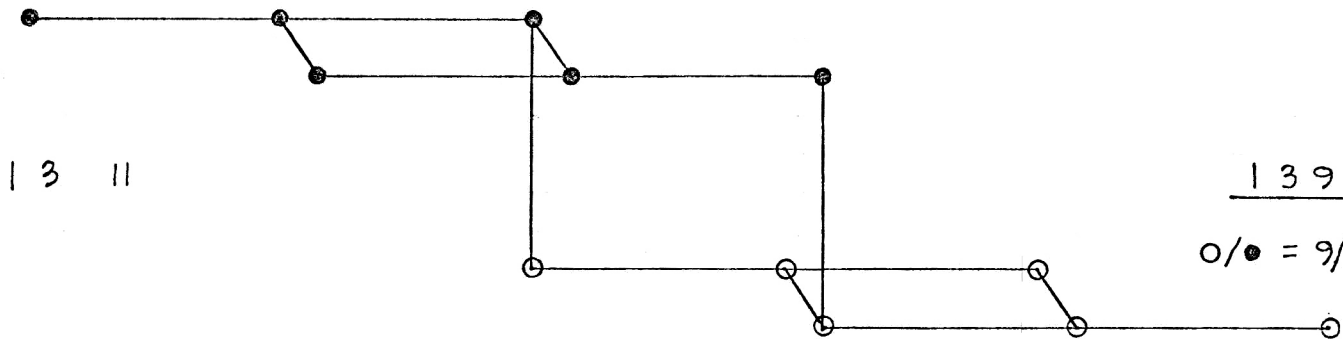

1 3 11

1 3 9 11  
 0/● = 9/5

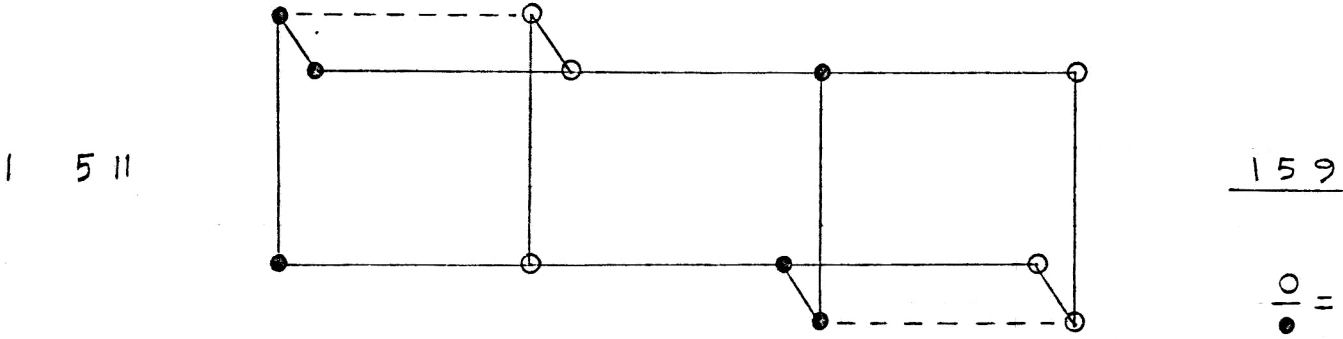

1 5 11

1 5 9 11  
 0/● = 9/3

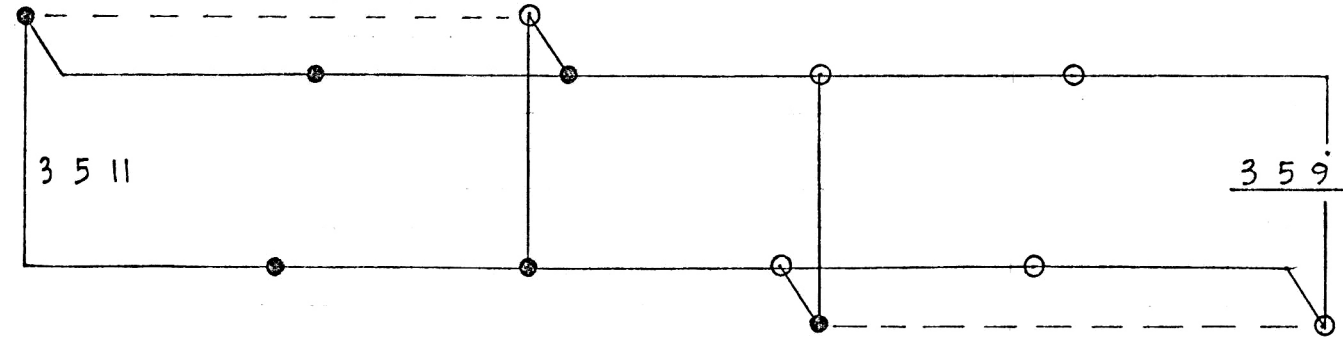

3 5 11

3 5 9 11  
 0/● = 9/1

1 3 7 9

5

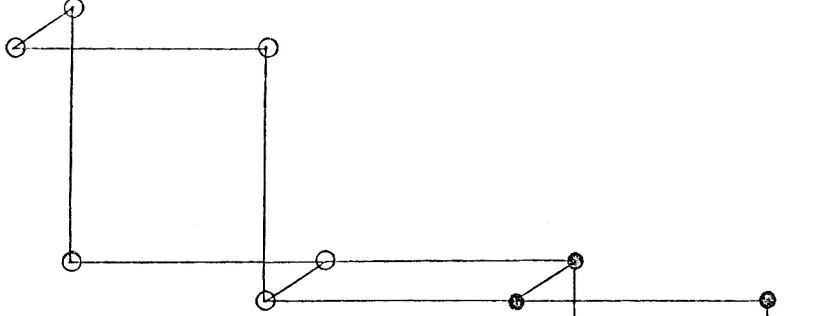

1 3 7

1 3 5 7

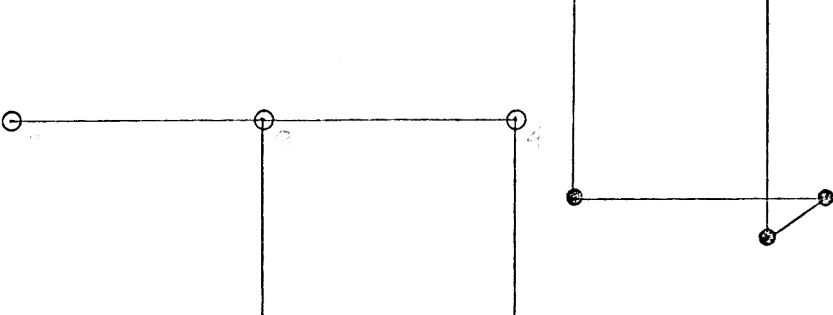

$$\frac{\circ}{\bullet} = \frac{5}{9}$$

1 3 9

1 3 5 9

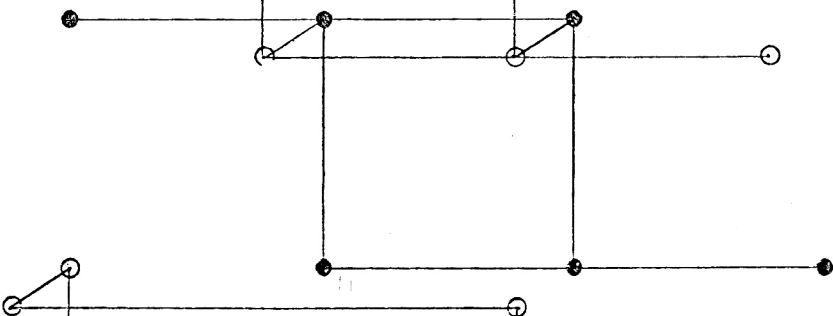

$$\frac{\circ}{\bullet} = \frac{5}{7}$$

1 7 9

1 5 7 9

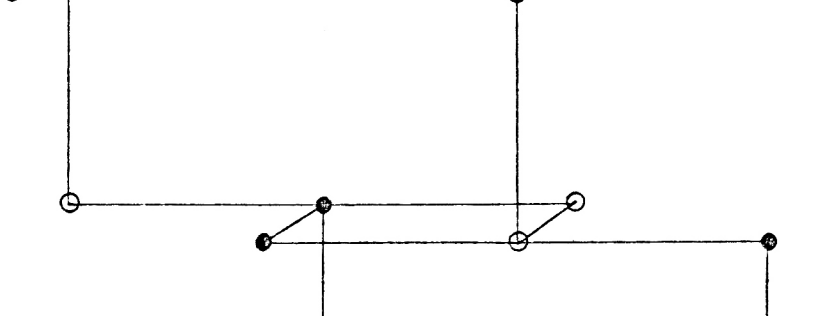

$$\frac{\circ}{\bullet} = \frac{5}{3}$$

3 7 9

3 5 7 9

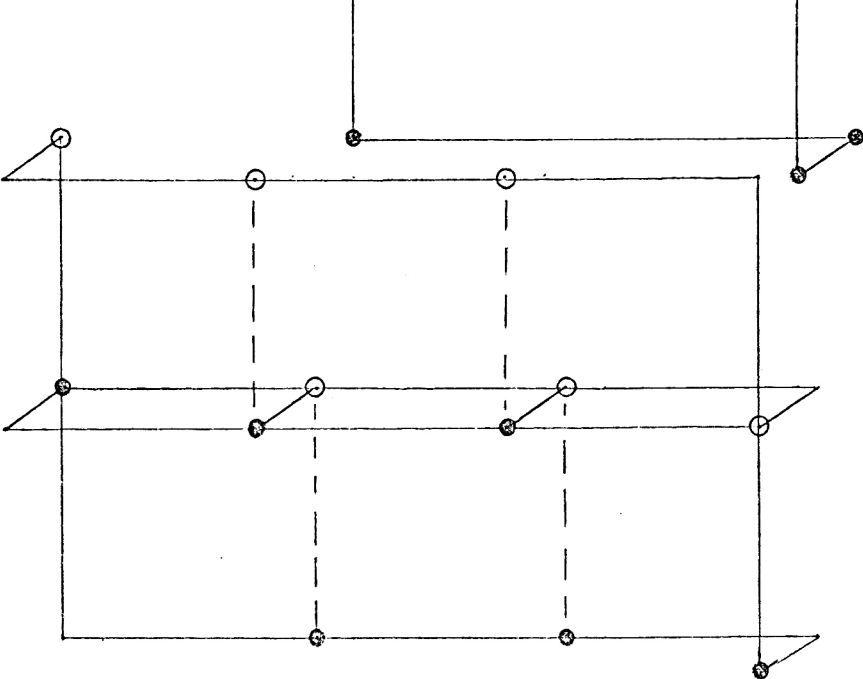

$$\frac{\circ}{\bullet} = \frac{5}{1}$$

1379

11

137

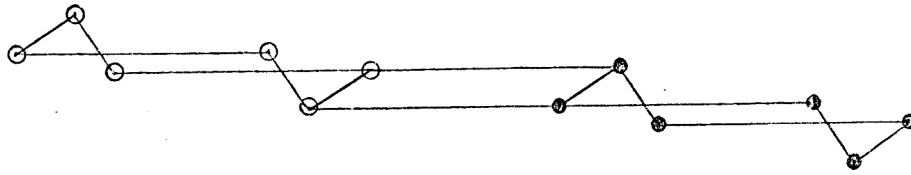

13711

$$\frac{0}{\bullet} = \frac{11}{9}$$

139

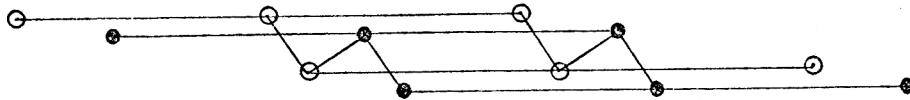

13911

$$\frac{0}{\bullet} = \frac{11}{7}$$

179

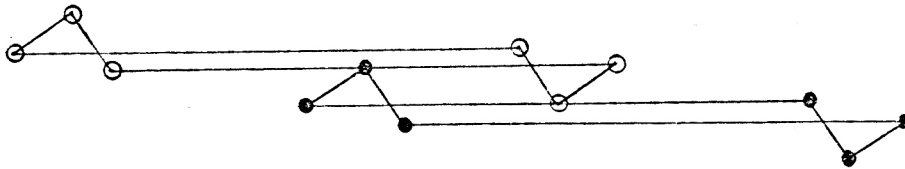

17911

$$\frac{0}{\bullet} = \frac{11}{3}$$

379

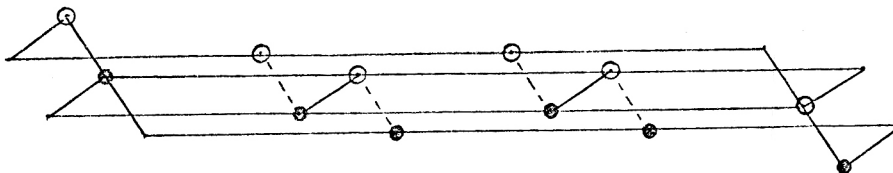

37911

$$\frac{0}{\bullet} = \frac{11}{1}$$

1 3 7 11

5

1 3 7

1 3 5 7

$$\frac{0}{\bullet} = \frac{5}{11}$$

1 3 11

1 3 5 11

$$\frac{0}{\bullet} = \frac{5}{7}$$

1 7 11

1 5 7 11

$$\frac{0}{\bullet} = \frac{5}{3}$$

3 7 11

3 5 7 11

$$\frac{0}{\bullet} = \frac{5}{1}$$

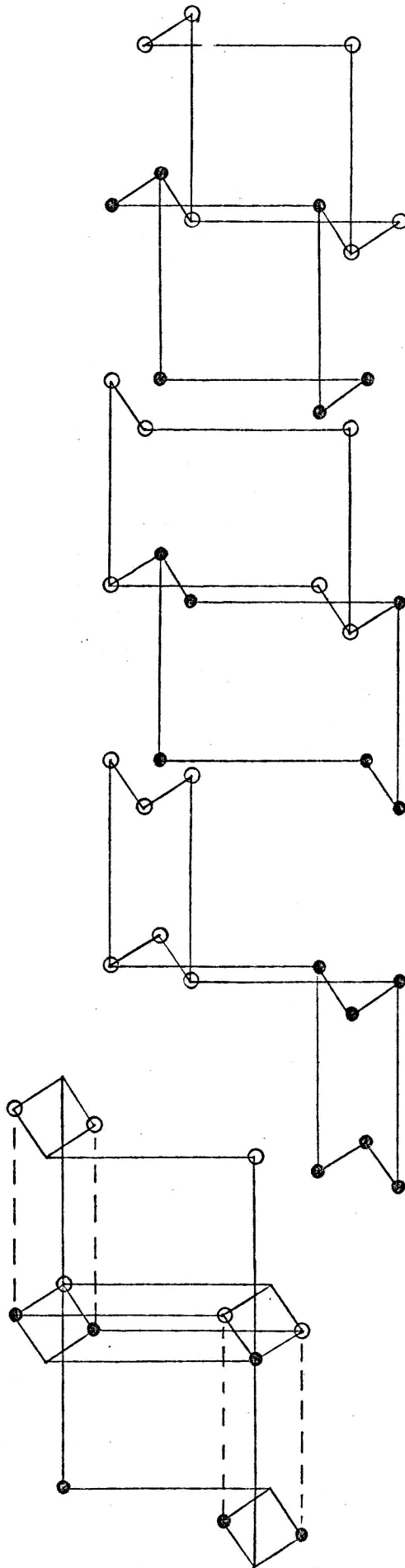

1 3 7 11

9

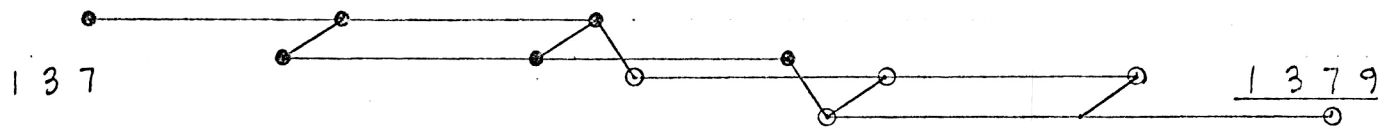

1 3 7 9

$$\frac{0}{\bullet} = \frac{9}{11}$$

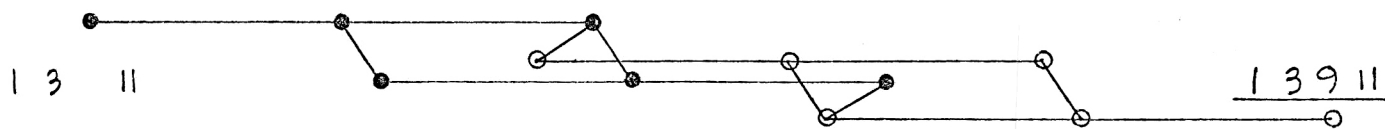

1 3 9 11

$$\frac{0}{\bullet} = \frac{9}{7}$$

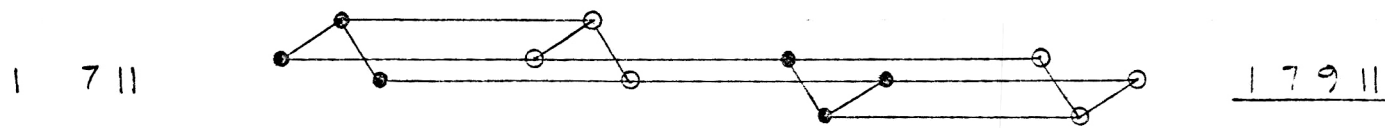

1 7 9 11

$$\frac{0}{\bullet} = \frac{9}{3}$$

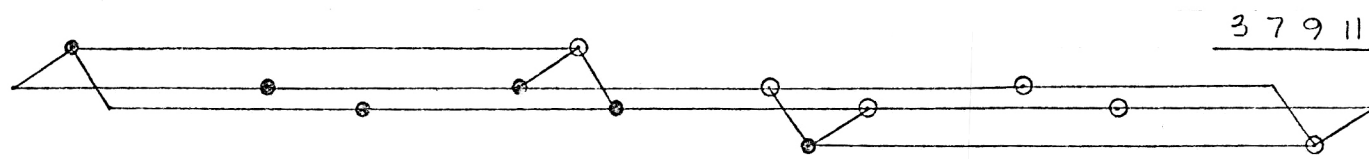

3 7 9 11

3 7 11

$$\frac{0}{\bullet} = \frac{9}{1}$$

13911

5

139

1359

$$\frac{0}{\bullet} = \frac{5}{11}$$

13 11

13511

$$\frac{0}{\bullet} = \frac{5}{9}$$

1 9 11

15911

$$\frac{0}{\bullet} = \frac{5}{3}$$

39 11

35911

$$\frac{0}{\bullet} = \frac{5}{1}$$

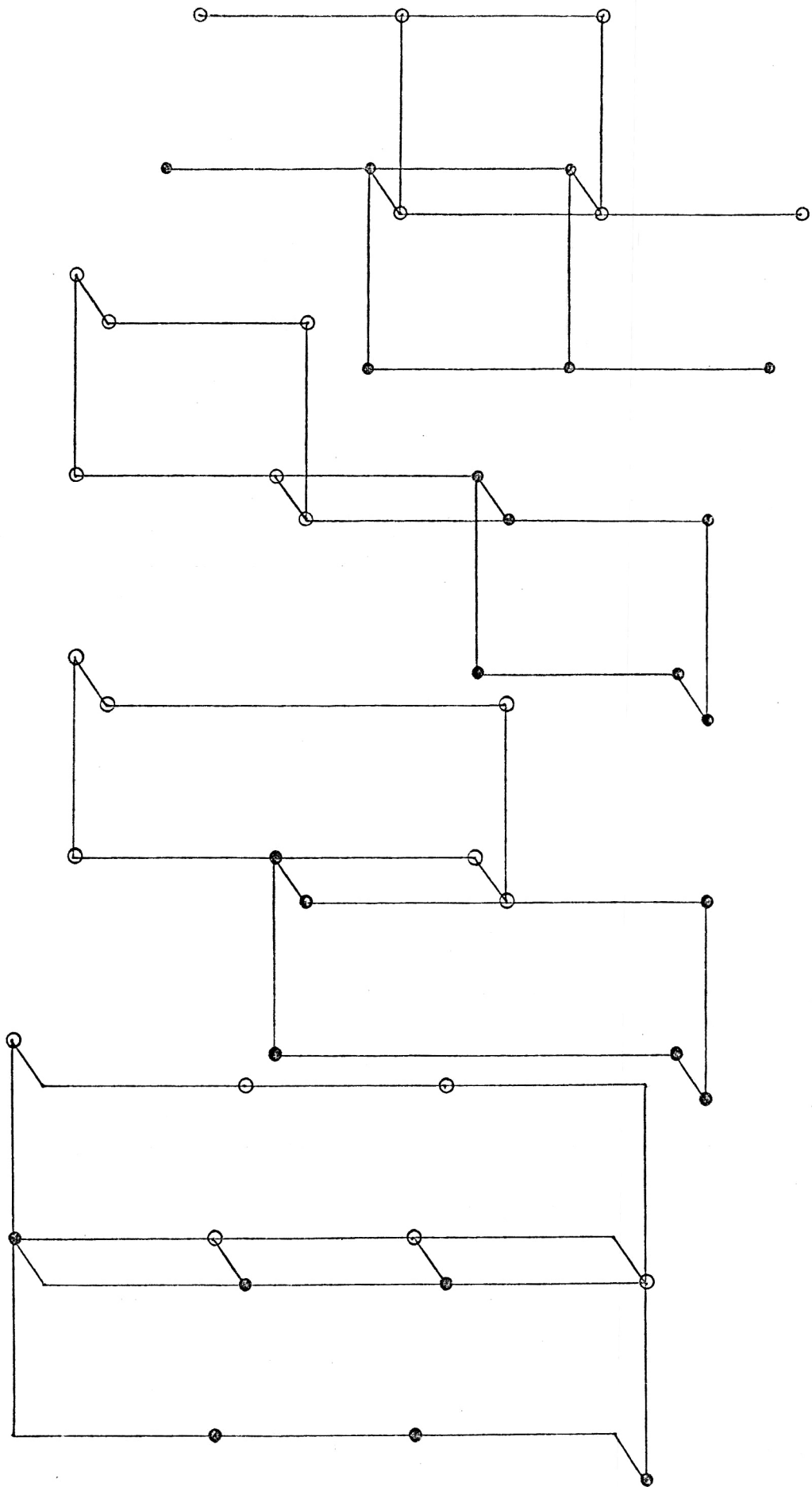

13911

7

139

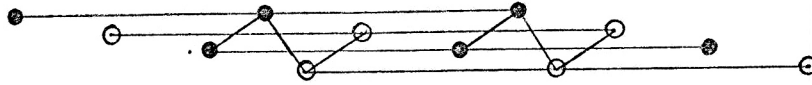

1379

$$\frac{0}{\bullet} = \frac{7}{11}$$

13 11

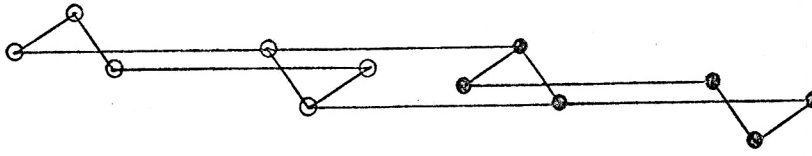

13711

$$\frac{0}{\bullet} = \frac{7}{9}$$

1 9 11

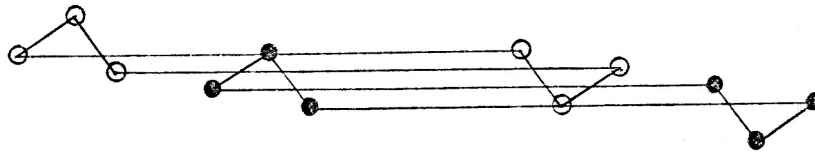

17911

$$\frac{0}{\bullet} = \frac{7}{3}$$

3911

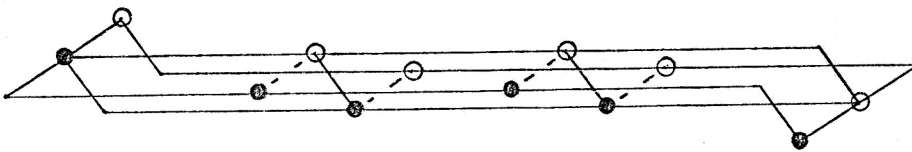

37911

$$\frac{0}{\bullet} = \frac{7}{1}$$

157

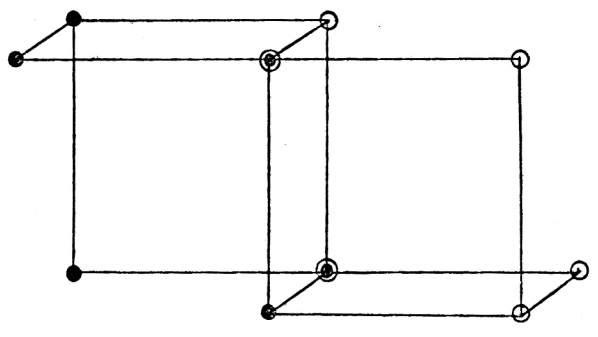

1357

$$\frac{0}{\bullet} = \frac{3}{9}$$

159

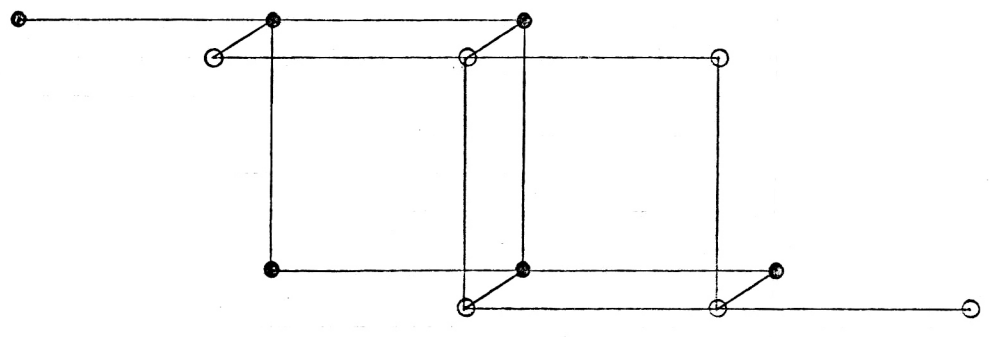

1359

$$\frac{0}{\bullet} = \frac{3}{7}$$

179

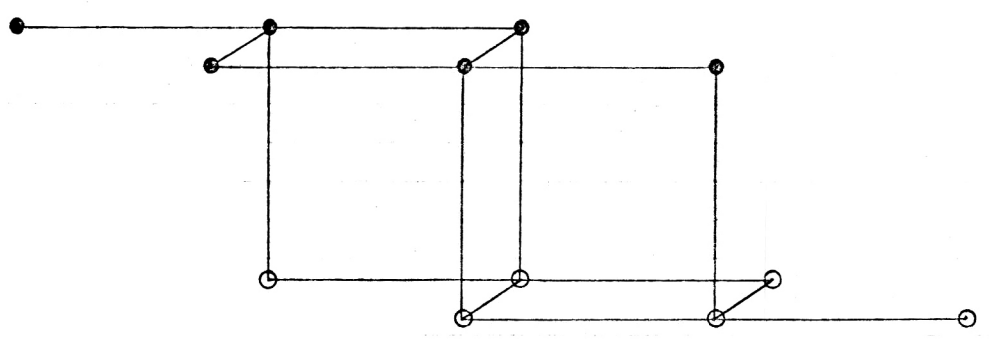

1379

$$\frac{0}{\bullet} = \frac{3}{5}$$

579

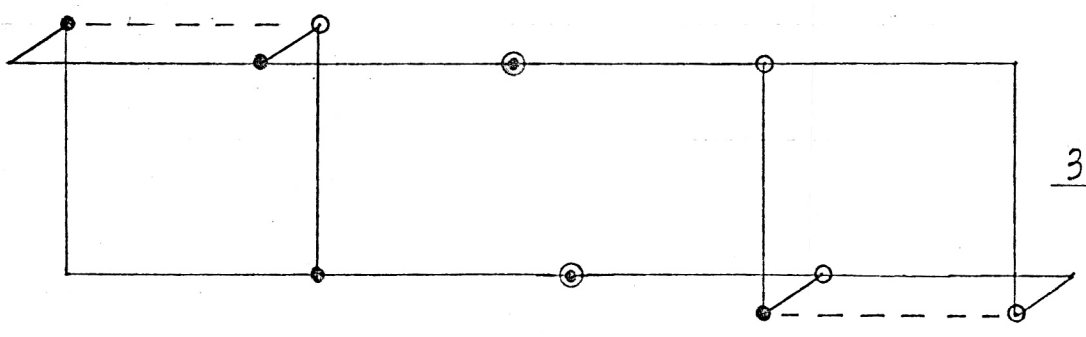

3579

$$\frac{0}{\bullet} = \frac{3}{1}$$



1579

11

157

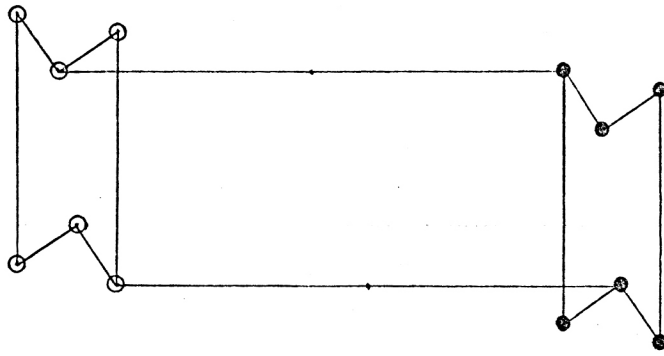

15711

$$\frac{\circ}{\bullet} = \frac{11}{9}$$

15 9

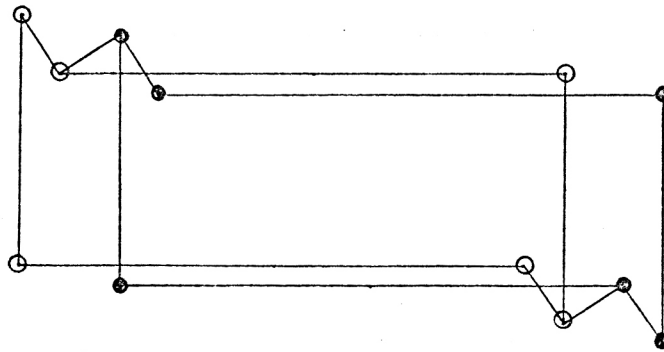

15911

$$\frac{\circ}{\bullet} = \frac{11}{7}$$

1 79

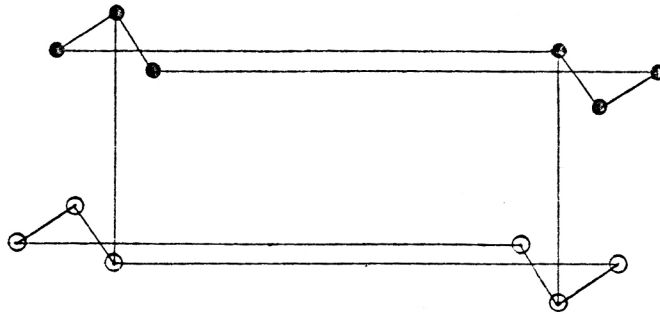

17911

$$\frac{\circ}{\bullet} = \frac{11}{5}$$

579

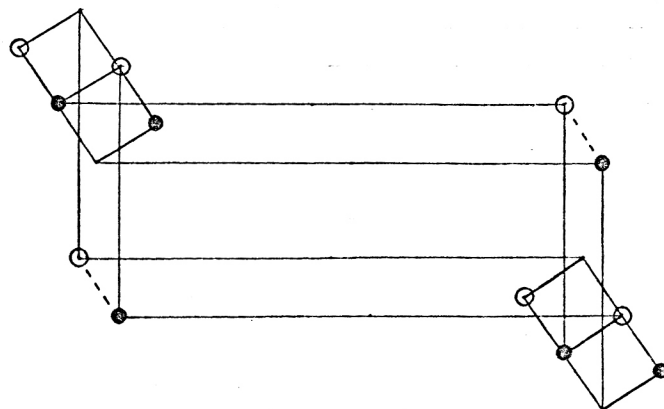

57911

$$\frac{\circ}{\bullet} = \frac{11}{1}$$

1 5 7 ||

1 5 7

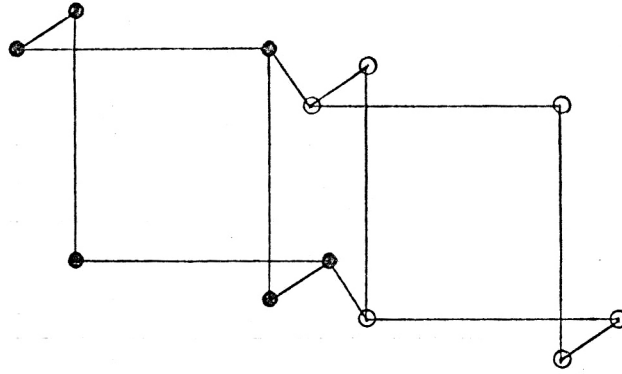

3

1 3 5 7

$$\frac{\circ}{\bullet} = \frac{3}{11}$$

1 5 ||

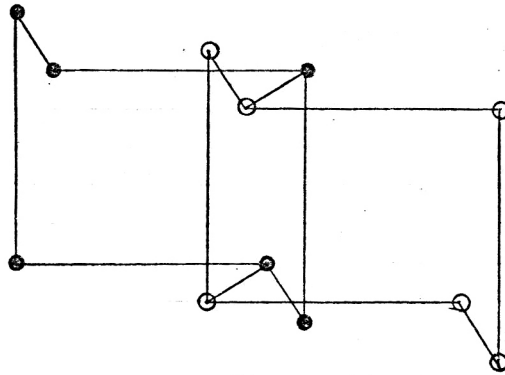

1 3 5 11

$$\frac{\circ}{\bullet} = \frac{3}{7}$$

1 7 ||

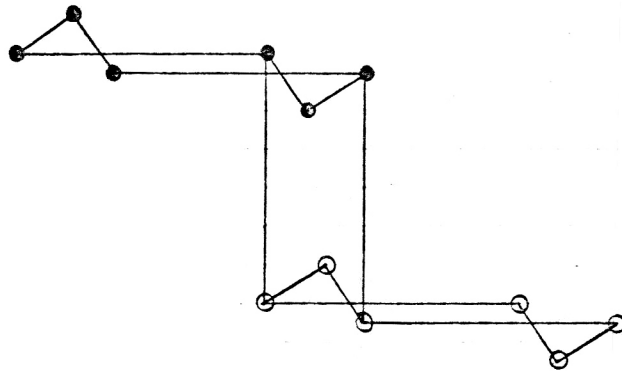

1 3 7 11

$$\frac{\circ}{\bullet} = \frac{3}{5}$$

5 7 ||

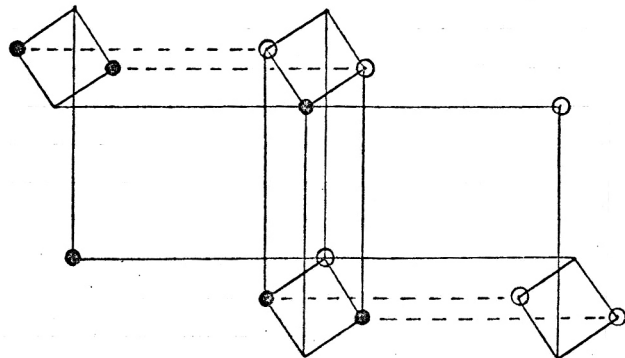

3 5 7 11

$$\frac{\circ}{\bullet} = \frac{3}{1}$$

15711

9

157

1579

$$\frac{\circ}{\bullet} = \frac{9}{11}$$

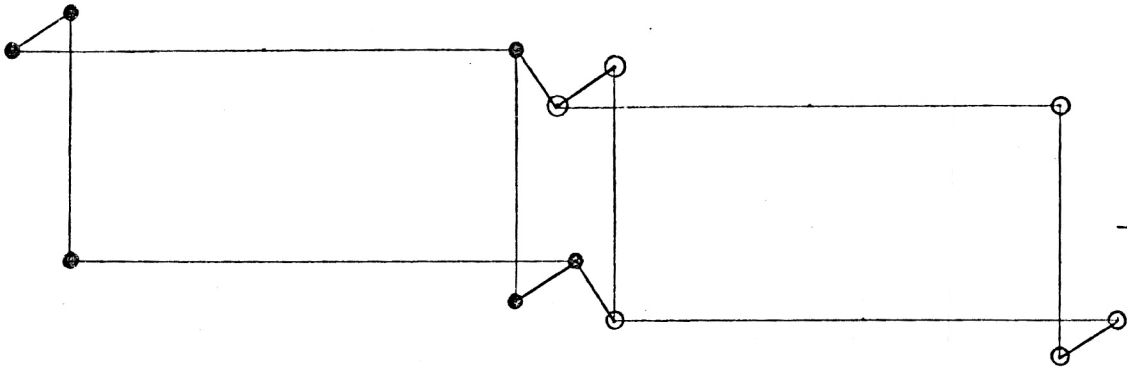

15 11

15911

$$\frac{\circ}{\bullet} = \frac{9}{7}$$

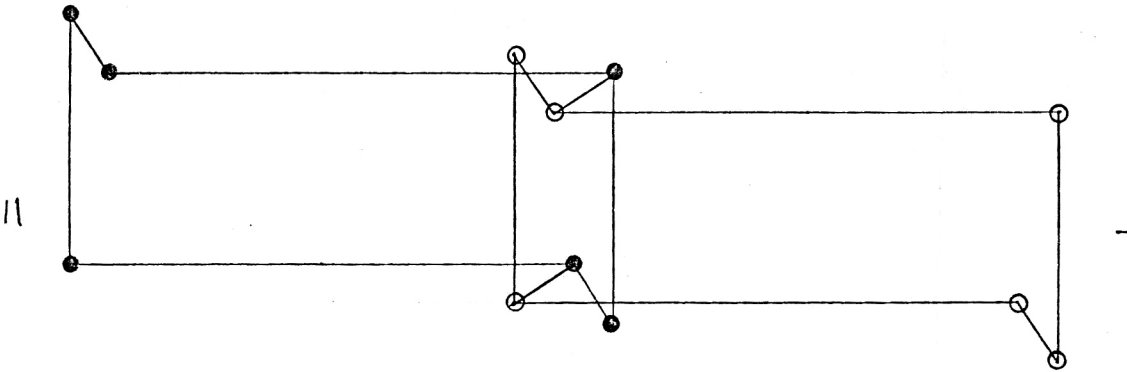

7 11

17911

$$\frac{\circ}{\bullet} = \frac{9}{5}$$

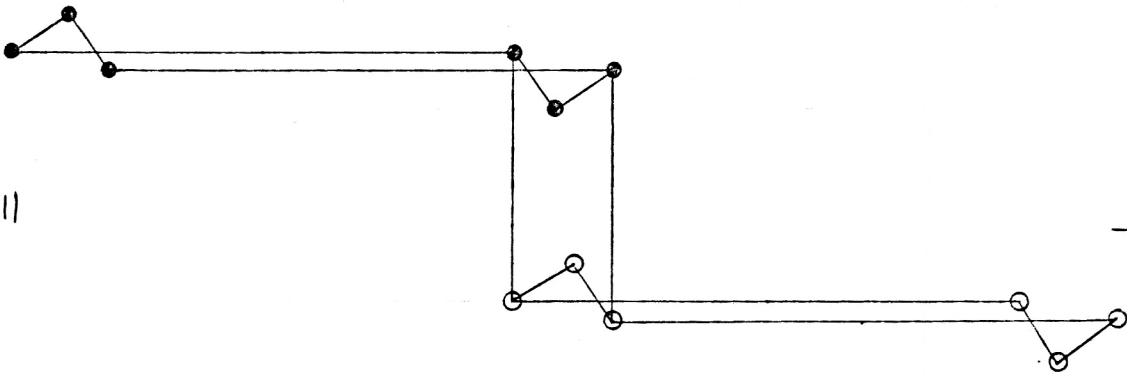

57 11

57911

$$\frac{\circ}{\bullet} = \frac{9}{1}$$

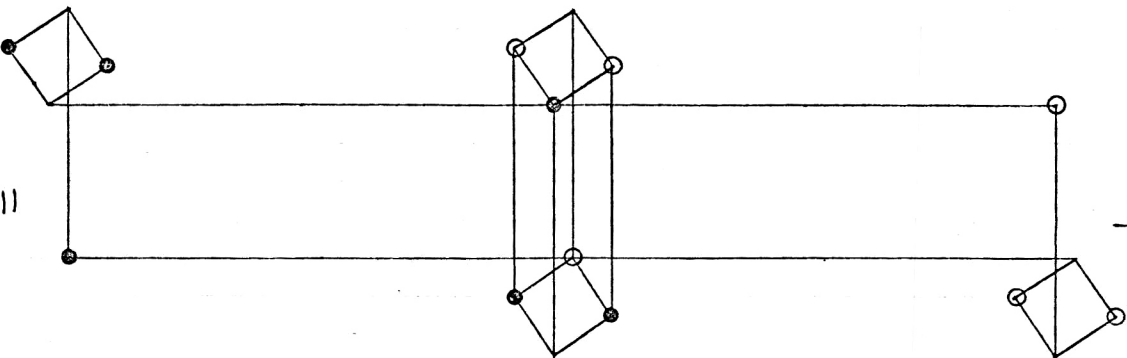

15911

3

159

1359

$$\frac{0}{\bullet} = \frac{3}{11}$$

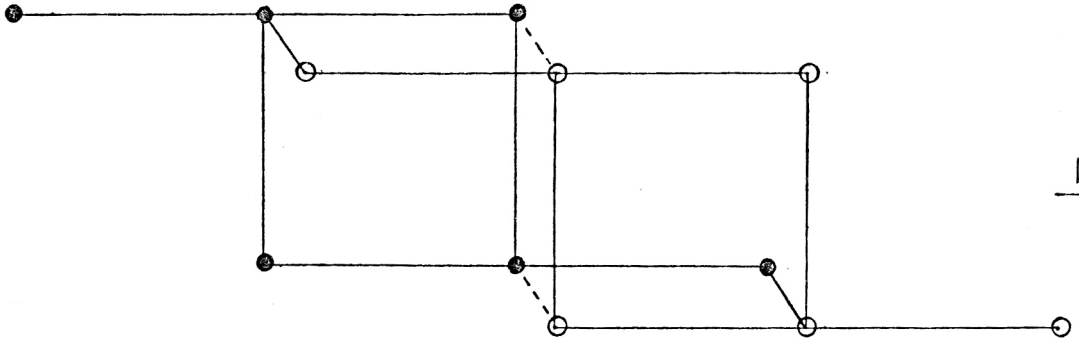

15 11

13511

$$\frac{0}{\bullet} = \frac{3}{9}$$

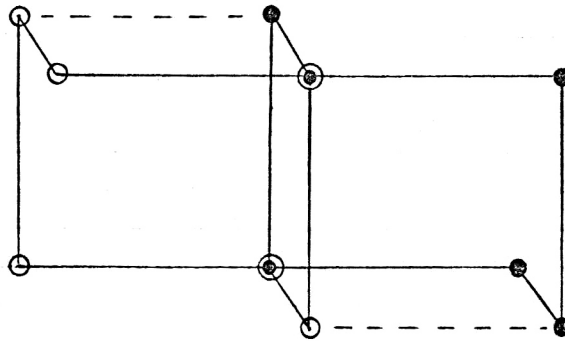

1 9 11

13911

$$\frac{0}{\bullet} = \frac{3}{5}$$

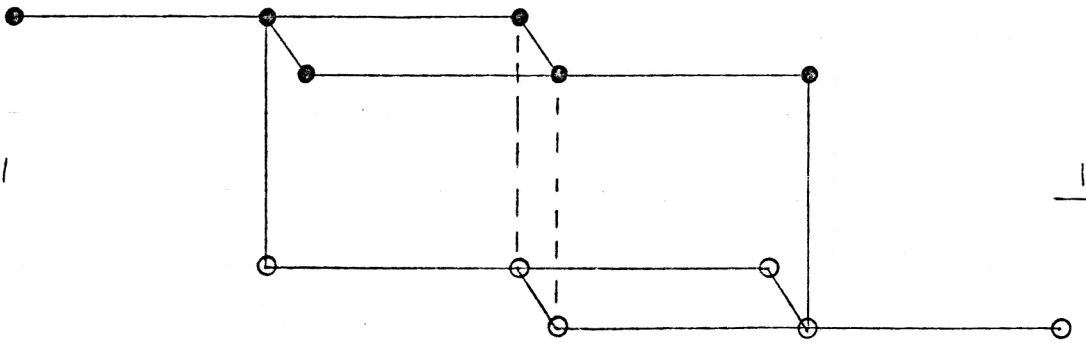

59 11

35911

$$\frac{0}{\bullet} = \frac{3}{1}$$

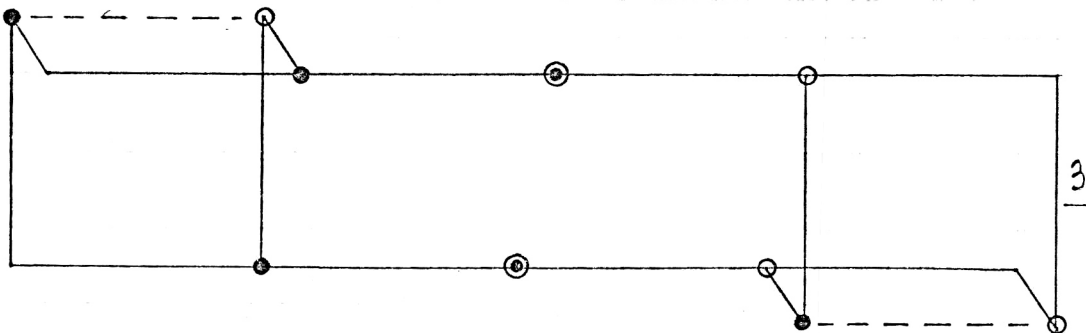

15911

159

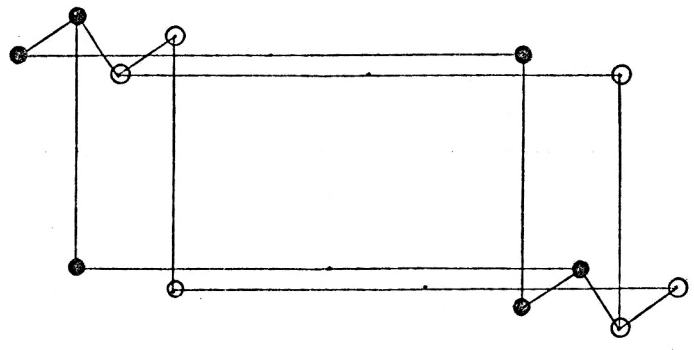

7

1579

$$\frac{0}{\bullet} = \frac{7}{11}$$

15 11

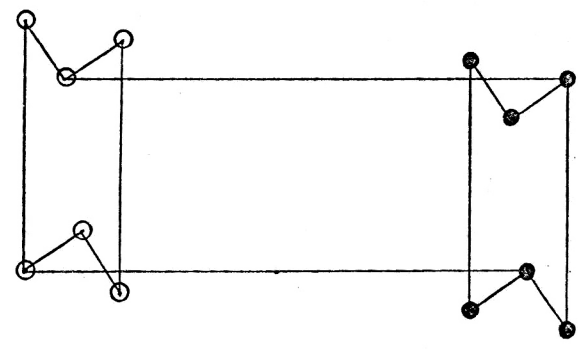

15711

$$\frac{0}{\bullet} = \frac{7}{9}$$

1 9 11

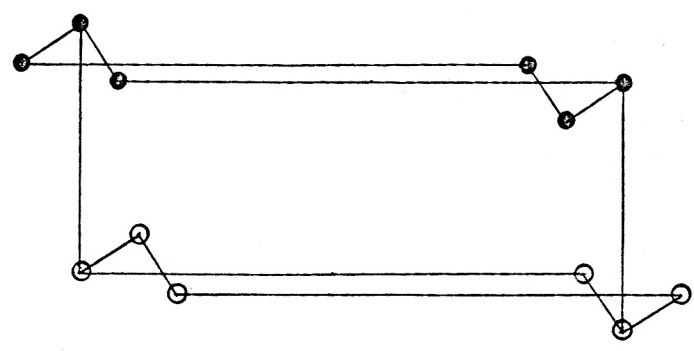

17911

$$\frac{0}{\bullet} = \frac{7}{5}$$

59 11

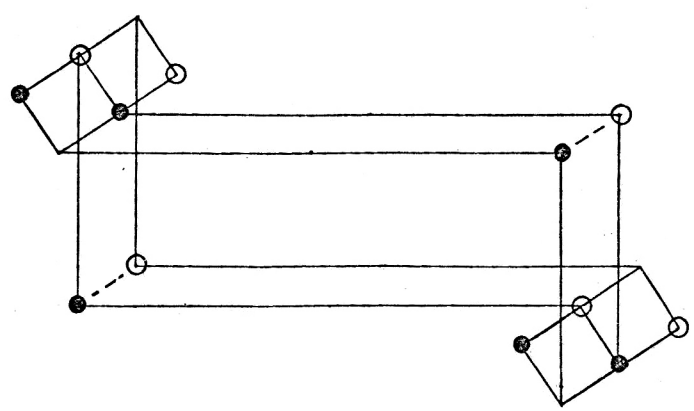

57911

$$\frac{0}{\bullet} = \frac{7}{1}$$

17911

3

179

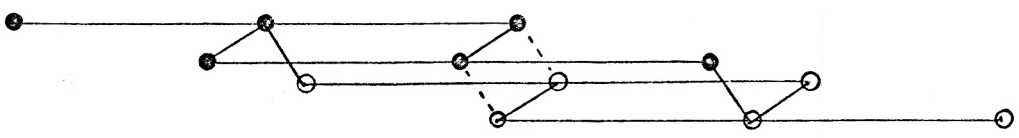

1379

$$\frac{0}{\bullet} = \frac{3}{11}$$

17 11

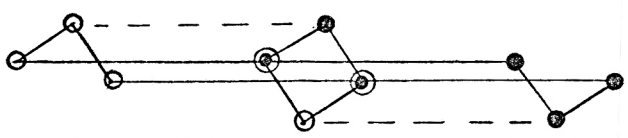

13711

$$\frac{0}{\bullet} = \frac{3}{9}$$

1 9 11

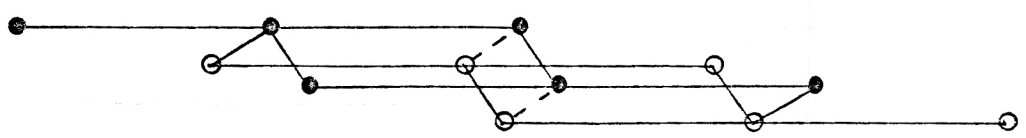

13911

$$\frac{0}{\bullet} = \frac{3}{7}$$

79 11

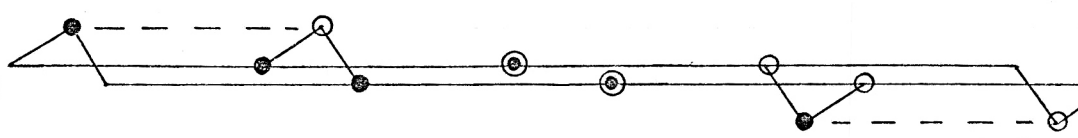

37911

$$\frac{0}{\bullet} = \frac{3}{1}$$

17911

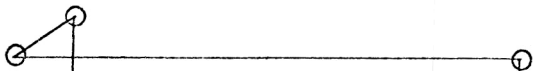

5

179

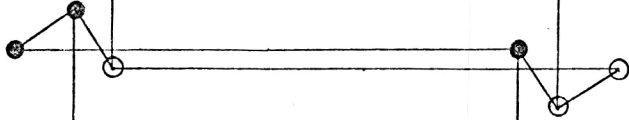

1579

$$\frac{0}{\bullet} = \frac{5}{11}$$

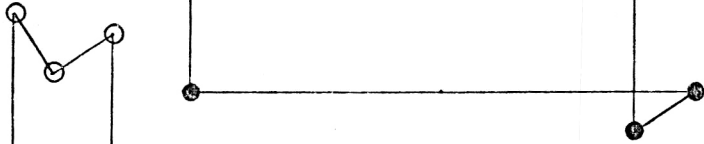

17 11

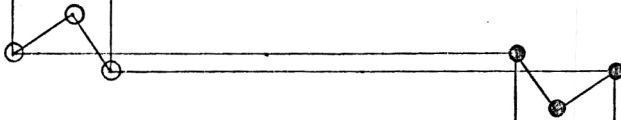

15711

$$\frac{0}{\bullet} = \frac{5}{9}$$



1 9 11

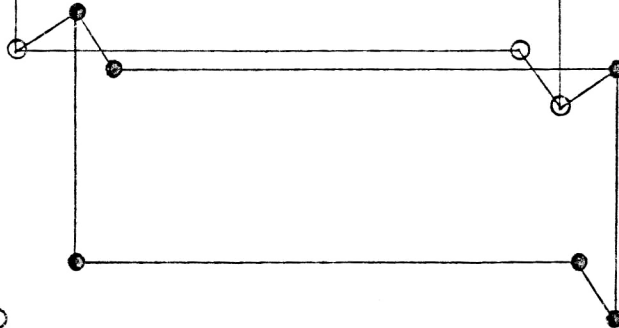

15911

$$\frac{0}{\bullet} = \frac{5}{7}$$

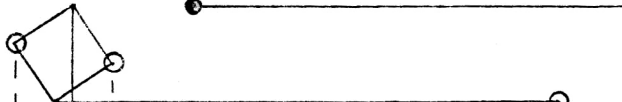

7911

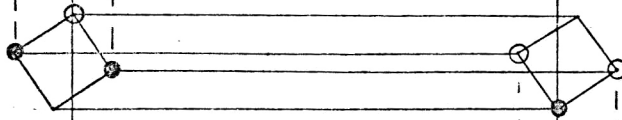

57911

$$\frac{0}{\bullet} = \frac{5}{1}$$

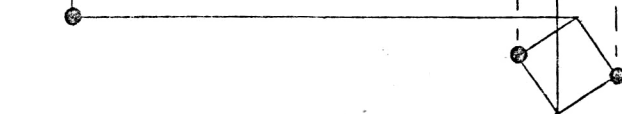

3 5 7 9

1

3 5 7

1 3 5 7

$$\frac{0}{\bullet} = \frac{1}{9}$$

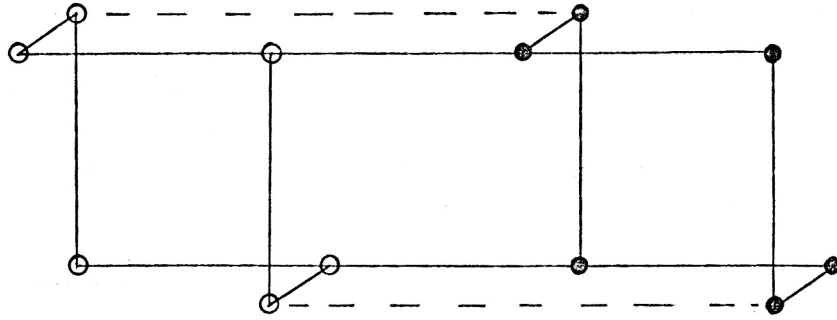

3 5 9

1 3 5 9

$$\frac{0}{\bullet} = \frac{1}{7}$$

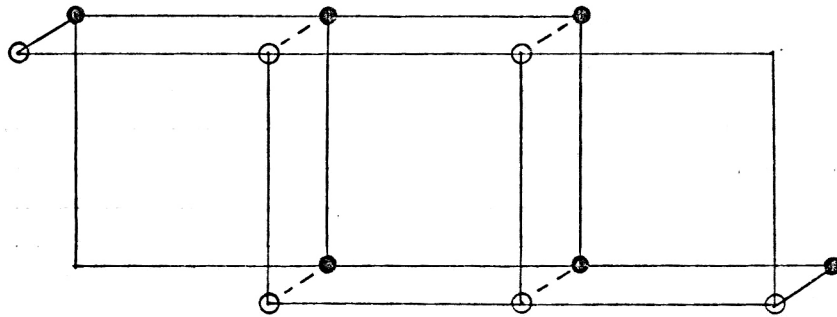

3 7 9

1 3 7 9

$$\frac{0}{\bullet} = \frac{1}{5}$$

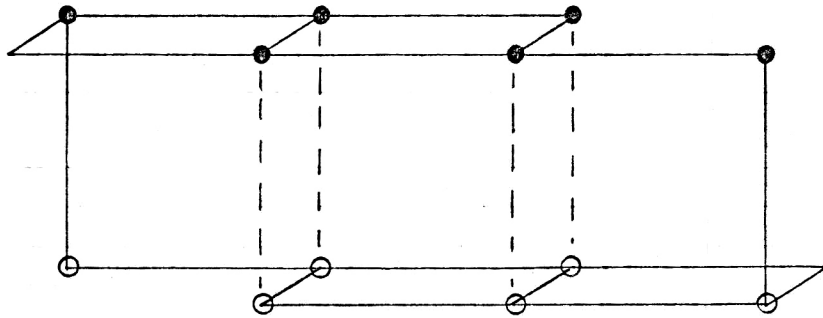

5 7 9

1 5 7 9

$$\frac{0}{\bullet} = \frac{1}{3}$$

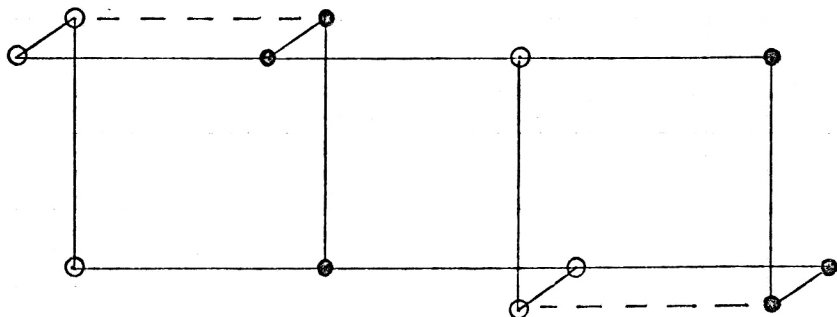



3 5 7 9

11

3 5 7

3 5 7 11

$$\frac{0}{\bullet} = \frac{11}{9}$$

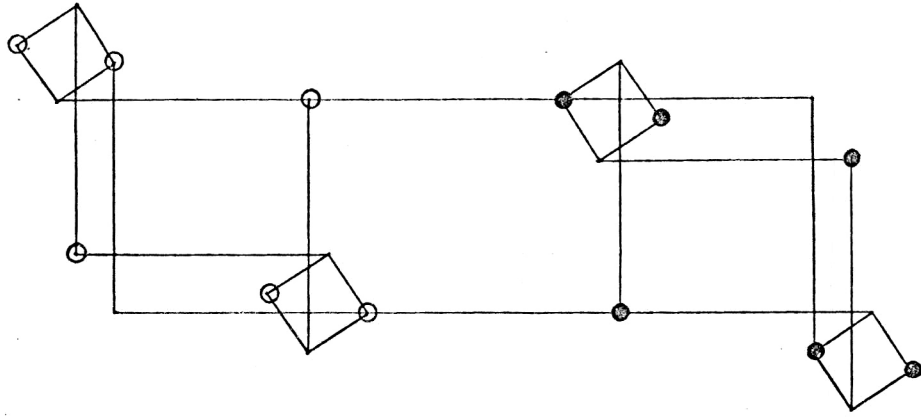

3 5 9

3 5 9 11

$$\frac{0}{\bullet} = \frac{11}{7}$$

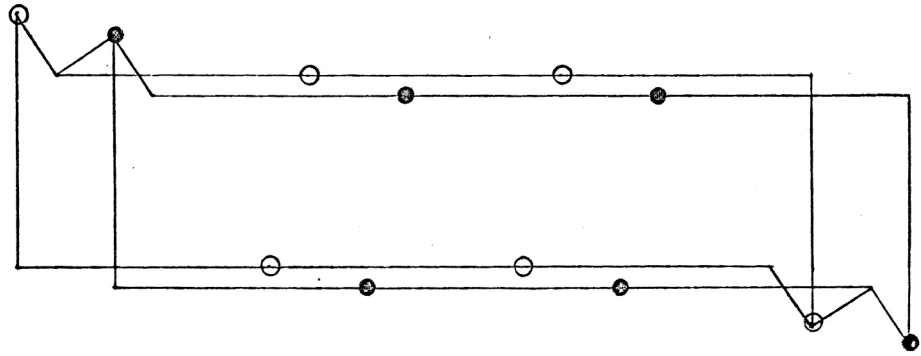

3 7 9

3 7 9 11

$$\frac{0}{\bullet} = \frac{11}{5}$$

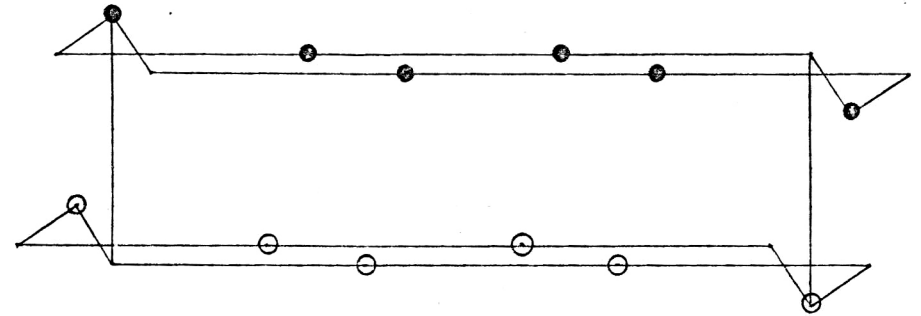

5 7 9

5 7 9 11

$$\frac{0}{\bullet} = \frac{11}{3}$$

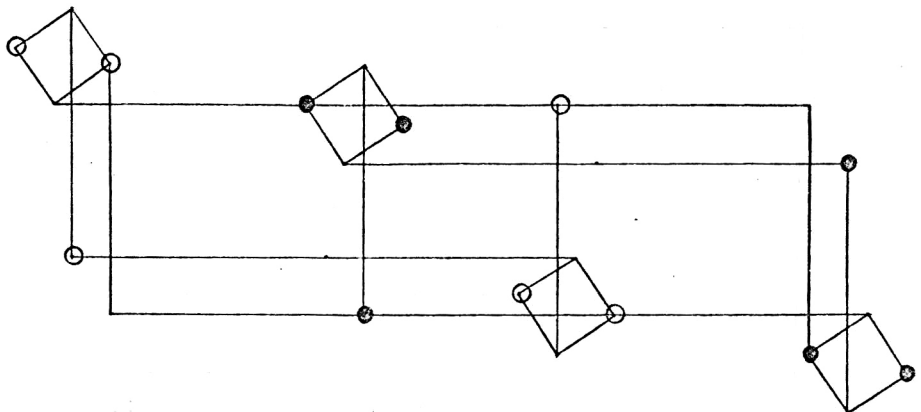

3 5 7 11

1

3 5 7

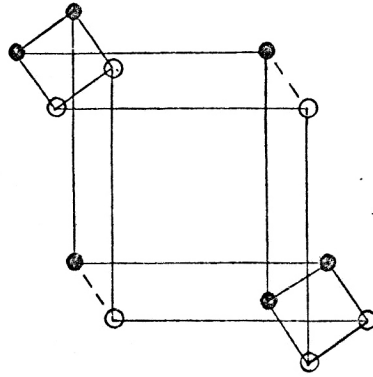

1 3 5 7

$$\frac{0}{\bullet} = \frac{1}{11}$$

3 5 11

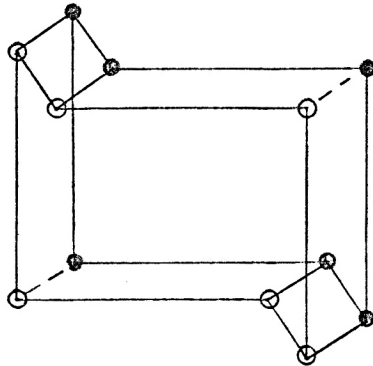

1 3 5 11

$$\frac{0}{\bullet} = \frac{1}{7}$$

3 7 11

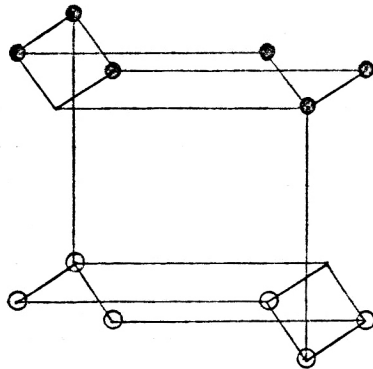

1 3 7 11

$$\frac{0}{\bullet} = \frac{1}{5}$$

5 7 11

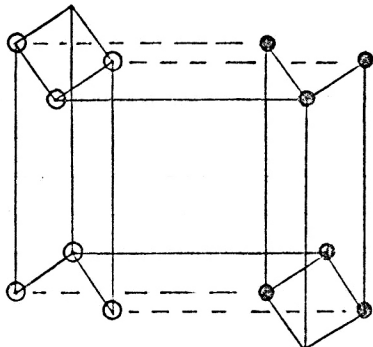

1 5 7 11

$$\frac{0}{\bullet} = \frac{1}{3}$$

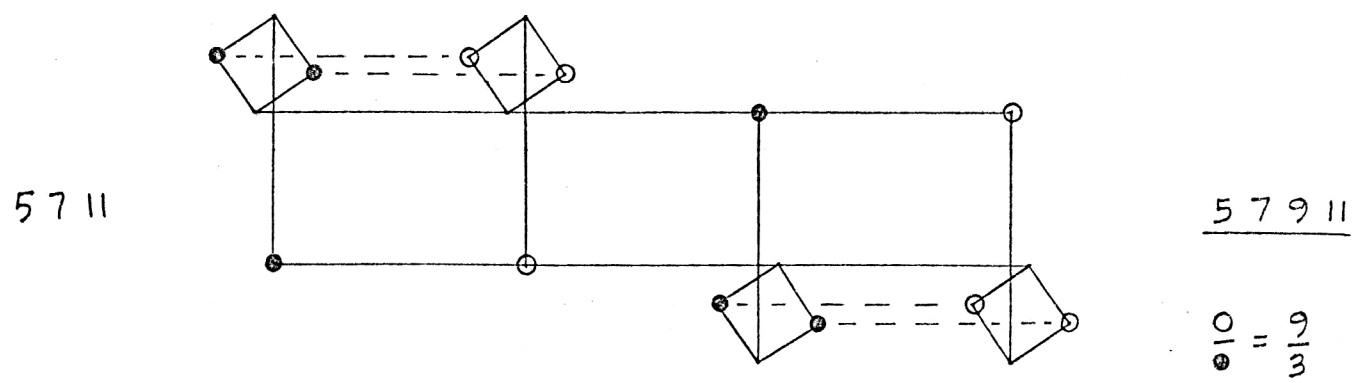
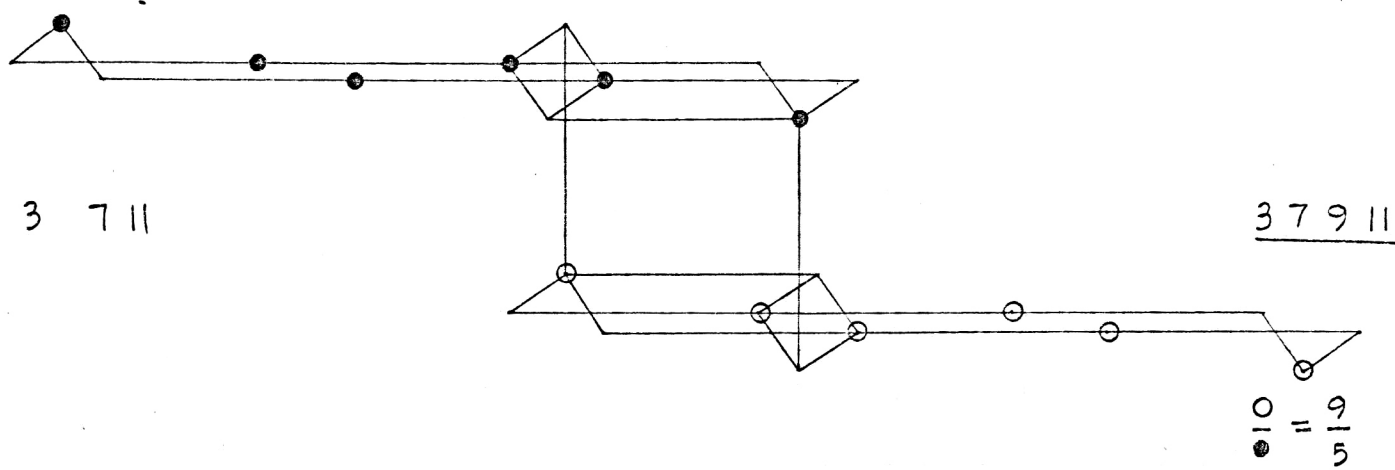
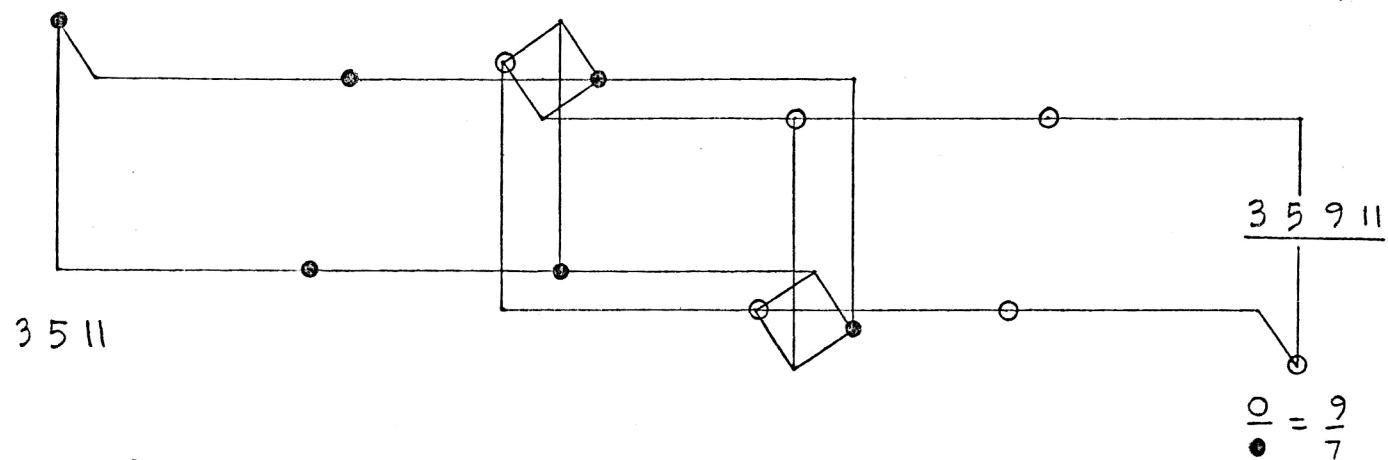
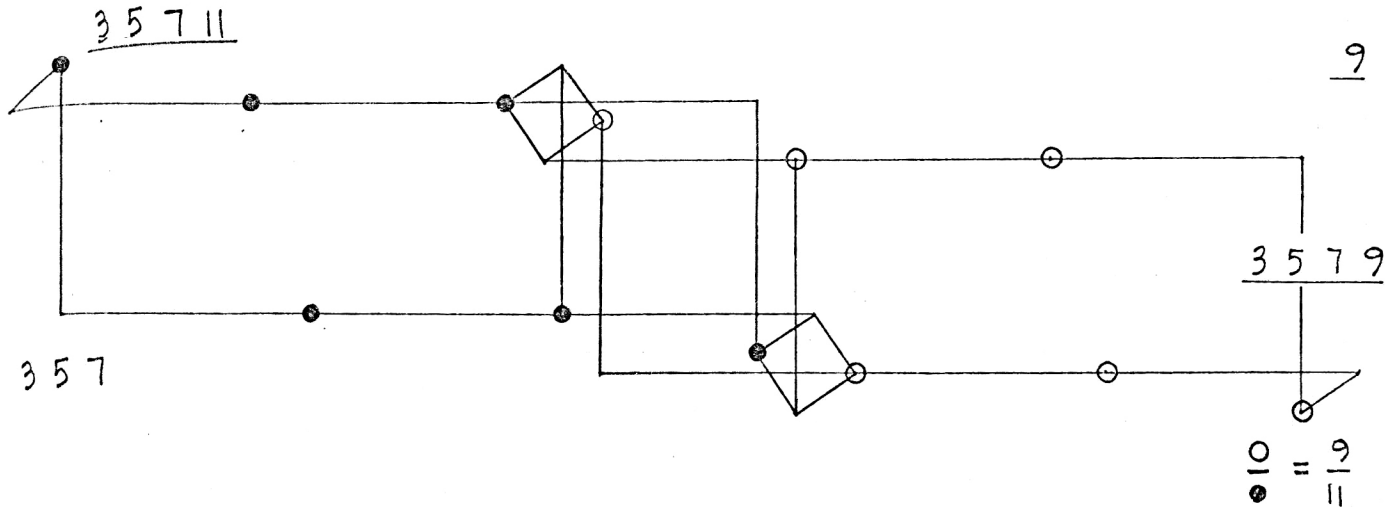

3 5 9 11

1

3 5 9

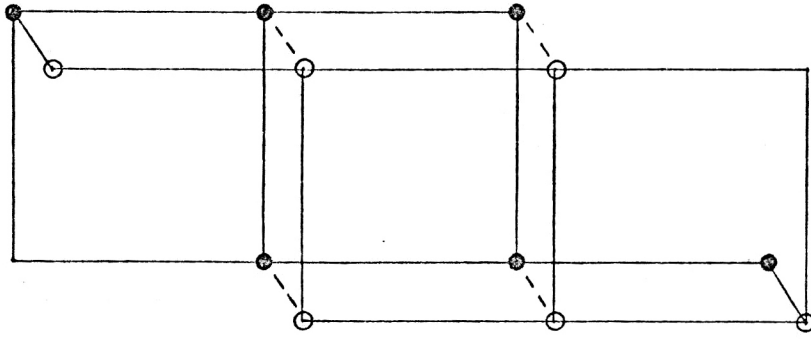

1 3 5 9

$$\frac{\circ}{\bullet} = \frac{1}{11}$$

3 5 11

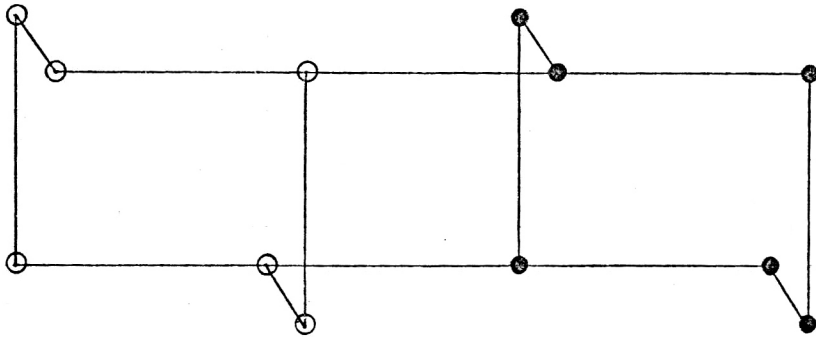

1 3 5 11

$$\frac{\circ}{\bullet} = \frac{1}{9}$$

3 9 11

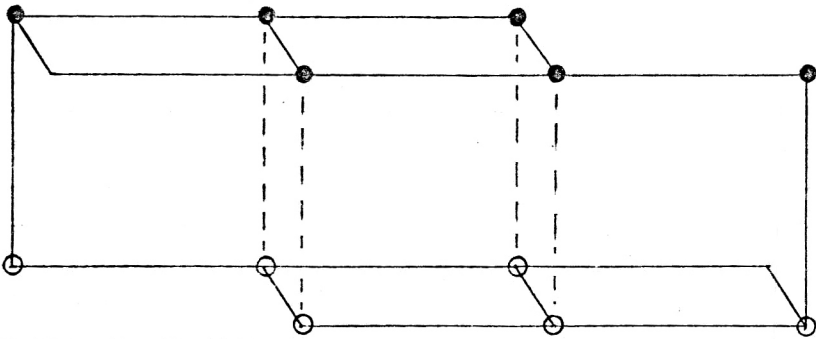

1 3 9 11

$$\frac{\circ}{\bullet} = \frac{1}{5}$$

5 9 11

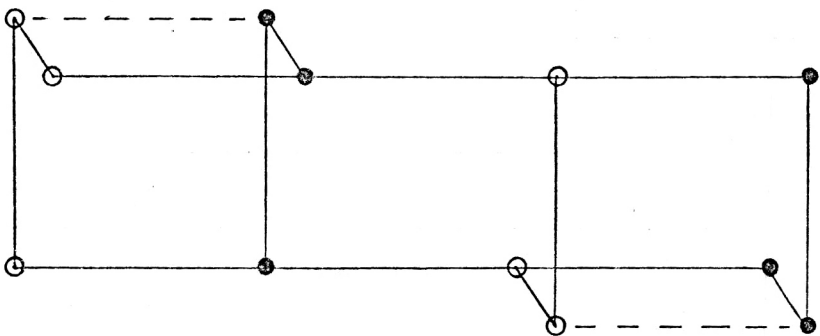

1 5 9 11

$$\frac{\circ}{\bullet} = \frac{1}{3}$$

35911

7

359

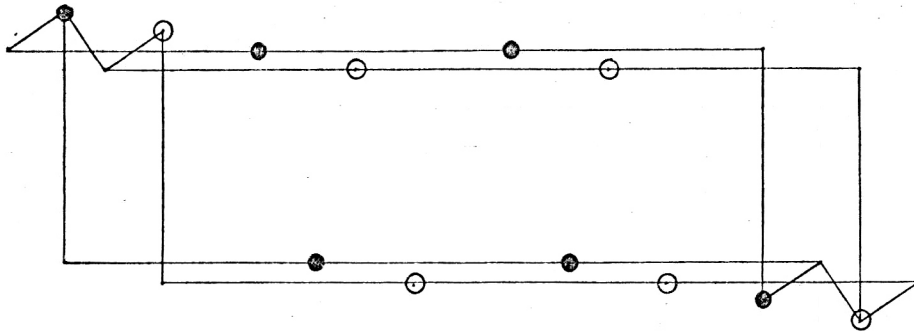

3579

$$\frac{\circ}{\bullet} = \frac{7}{11}$$

35 11

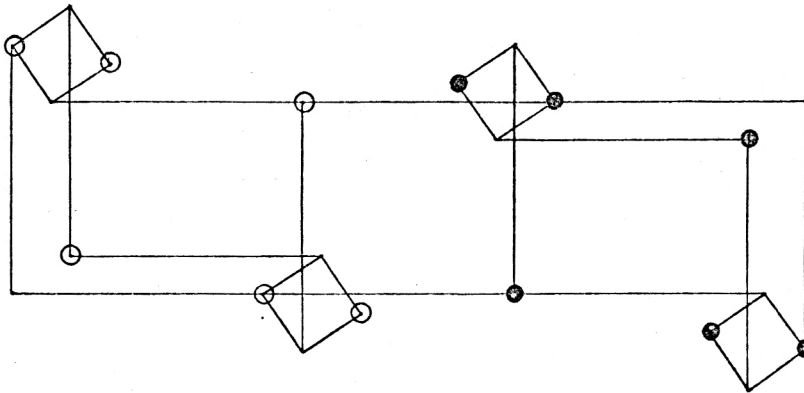

35711

$$\frac{\circ}{\bullet} = \frac{7}{9}$$

3 9 11

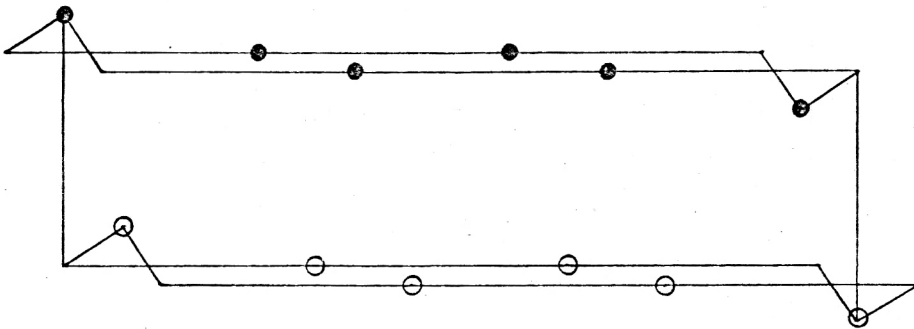

37911

$$\frac{\circ}{\bullet} = \frac{7}{5}$$

5911

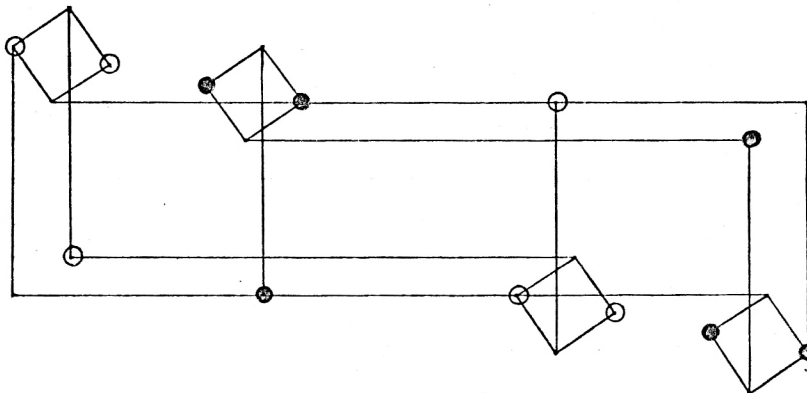

57911

$$\frac{\circ}{\bullet} = \frac{7}{3}$$

3 7 9 11

1

3 7 9

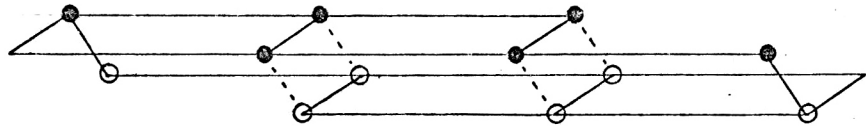

1 3 7 9

$$\frac{\circ}{\bullet} = \frac{1}{11}$$

3 7 11

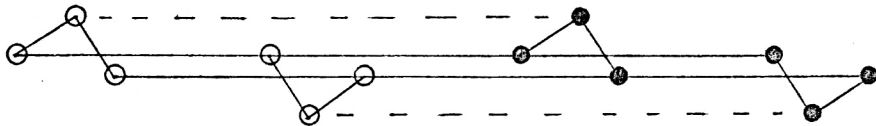

1 3 7 11

$$\frac{\circ}{\bullet} = \frac{1}{9}$$

3 9 11

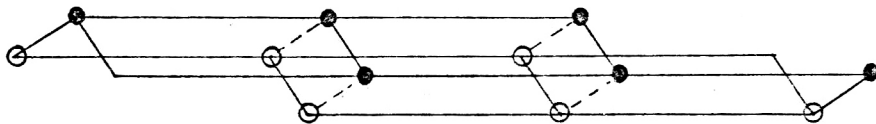

1 3 9 11

$$\frac{\circ}{\bullet} = \frac{1}{7}$$

7 9 11

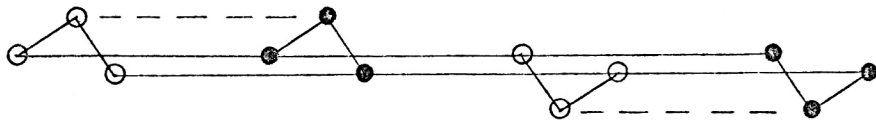

1 7 9 11

$$\frac{\circ}{\bullet} = \frac{1}{3}$$

3 7 9 11

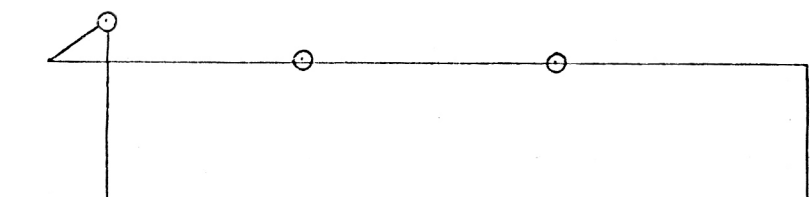

5

3 7 9

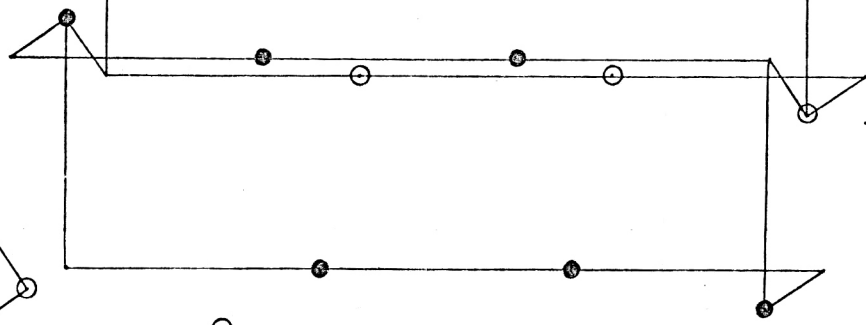

3 5 7 9

$$\frac{\circ}{\bullet} = \frac{5}{11}$$

3 7 11

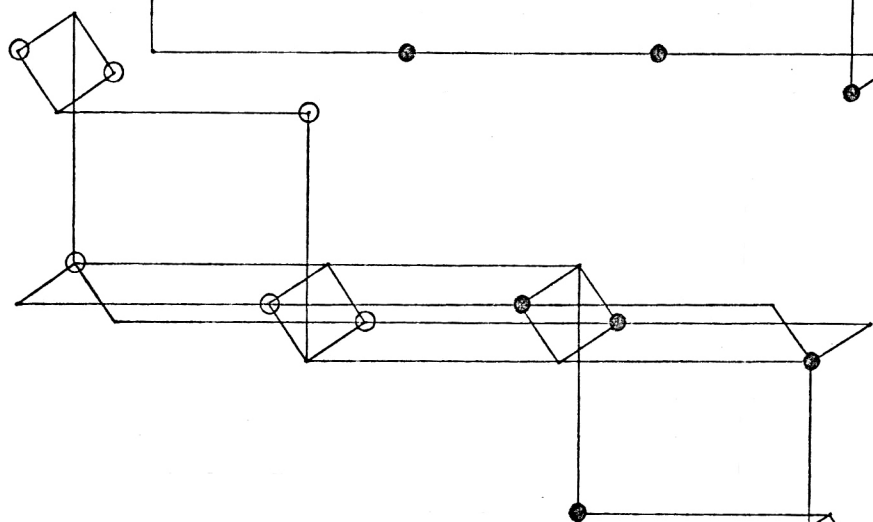

3 5 7 11

$$\frac{\circ}{\bullet} = \frac{5}{9}$$

3 9 11

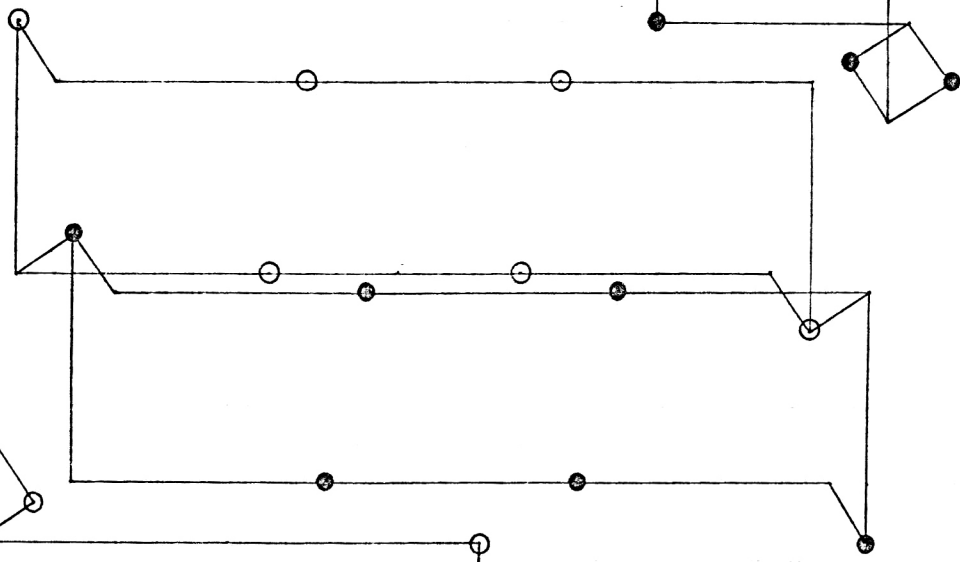

3 5 9 11

$$\frac{\circ}{\bullet} = \frac{5}{7}$$

7 9 11

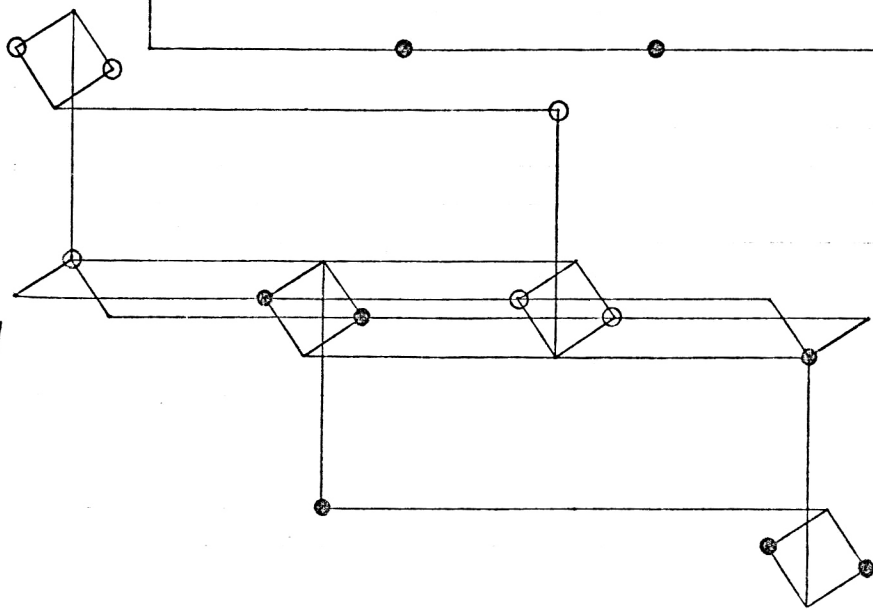

5 7 9 11

$$\frac{\circ}{\bullet} = \frac{5}{3}$$

57911

1

579

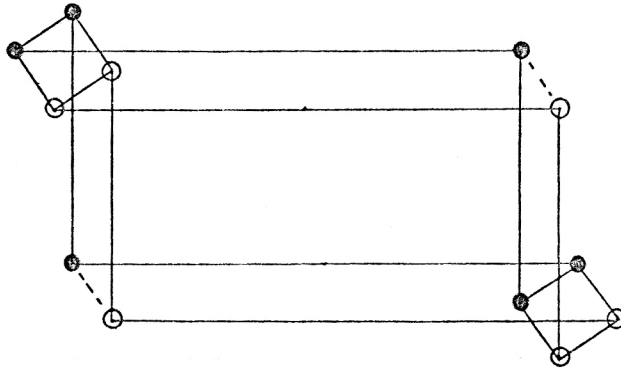

1579

$$\frac{0}{\bullet} = \frac{1}{11}$$

57 11

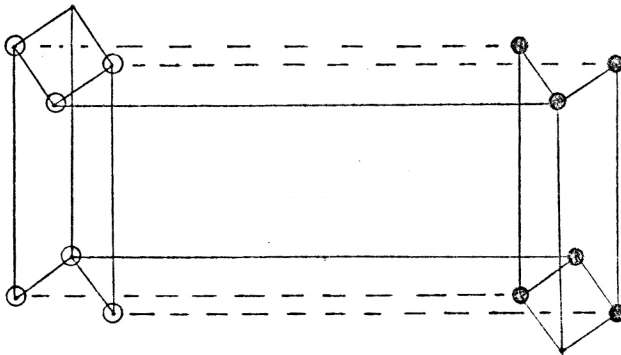

15711

$$\frac{0}{\bullet} = \frac{1}{9}$$

5 911

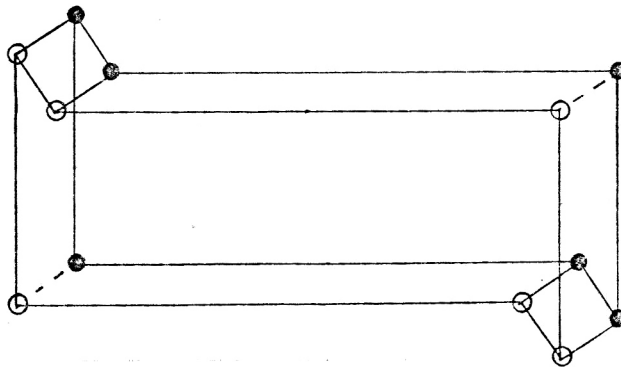

15911

$$\frac{0}{\bullet} = \frac{1}{7}$$

7911

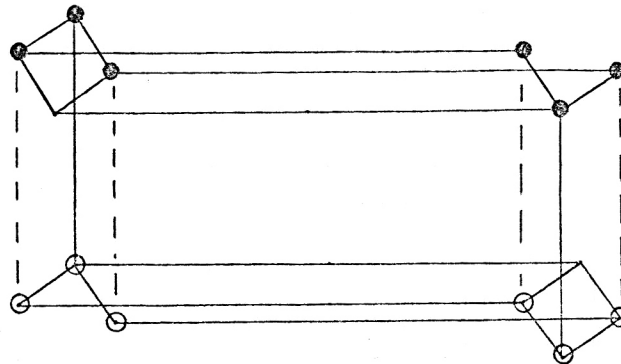

17911

$$\frac{0}{\bullet} = \frac{1}{5}$$



57911

3

579

3579

$$\frac{0}{\bullet} = \frac{3}{11}$$

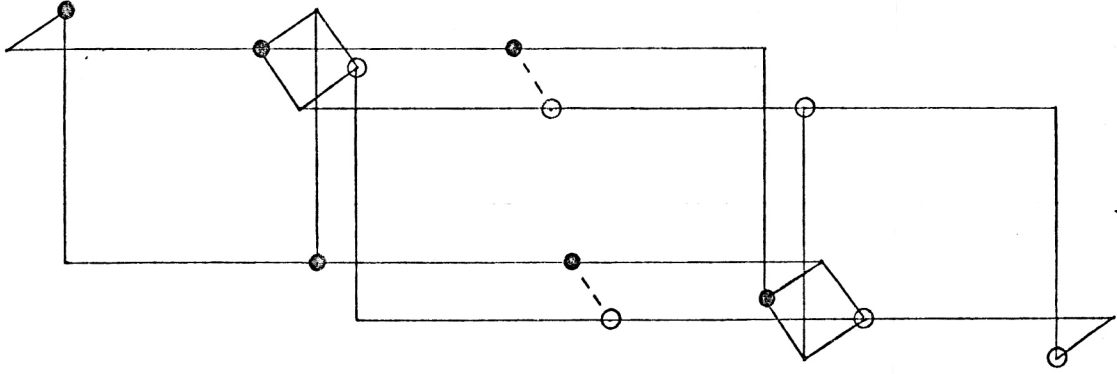

57 11

35711

$$\frac{0}{\bullet} = \frac{3}{9}$$

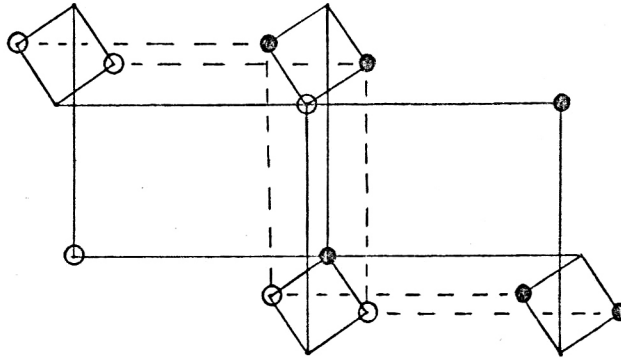

5 9 11

35911

$$\frac{0}{\bullet} = \frac{3}{7}$$

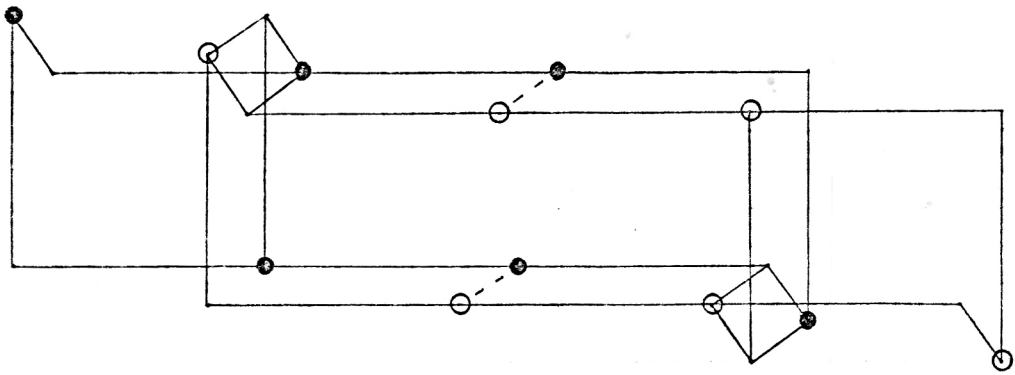

79 11

37911

$$\frac{0}{\bullet} = \frac{3}{5}$$

